



# TEXAS

## VIRTUAL ACADEMY<sup>SM</sup>

---

### 3<sup>rd</sup>-8<sup>th</sup> Grade

## Parent Orientation Guide

### 2014-2015



BLAZING TRAILS TO SUCCESS!

Visit the TXVA Secrets of Success Website at <http://txva.k12start.com/>

**Texas Virtual Academy**  
1955 Lakeway Drive, Suite 250B  
Lewisville, TX 75057  
972-420-1404  
Fax: 888-506-6777

## Table of Contents

TXVA ORGANIZATION CHART .....	4
MISSION STATEMENT .....	4
INTRODUCTION .....	5
IMPORTANT DATES.....	7
WEEKLY OPEN OFFICE WITH ADMINISTRATION .....	8
QUESTIONS OR CONCERNS? .....	8
ADMISSION & ENTRANCE REQUIREMENTS .....	9
NEW STUDENT ORIENTATION PROGRAM .....	9
STUDENT CODE OF CONDUCT .....	10
EXPECTATIONS .....	11
I UNDERSTAND AND AGREE.....	12
ACADEMIC INTEGRITY POLICY.....	13
COMPLIANCY PLAN .....	14
INSTRUCTIONAL TIME .....	14
ATTENDANCE & TRUANCY POLICY .....	15
TRUANCY PROCESS.....	17
ATTENDANCE FAQs.....	18
STUDENT RECORDS .....	20
WITHDRAWALS .....	22
ACADEMIC ADVANCEMENT .....	23
MANDATORY TESTING INFORMATION .....	24
SCANTRON .....	25
STUDY ISLAND .....	25
GRADING POLICY & REPORT CARDS .....	26
STUDENT SUCCESS INITIATIVE.....	30
STATE PHYSICAL EDUCATION REQUIREMENT .....	31
COURSE PROMOTIONS .....	31
FINISHING THE YEAR EARLY .....	32
WORK SAMPLES .....	32
COURSE ORDER CHART .....	33
ASSESSMENT .....	34
CLASS CONNECTS.....	34
SUPPLEMENTAL ACTIVITIES .....	35
STRONG START WEB SITE.....	35
PARENT/STUDENT/TEACHER COMMUNICATION.....	35
CONFERENCES .....	36
STUDENT GOALS & INDIVIDUAL LEARNING PLANS (ILPs) .....	36
CLASS MEETINGS .....	37
ADMINISTRATION TOWN HALL MEETINGS .....	37

<b>CHILD FIND .....</b>	<b>37</b>
<b>SPECIAL EDUCATION SERVICES .....</b>	<b>38</b>
<b>RELATED SERVICES .....</b>	<b>39</b>
<b>504 SERVICES.....</b>	<b>39</b>
<b>RESPONSE TO INTERVENTION (RTI).....</b>	<b>40</b>
<b>ADVANCED LEARNERS .....</b>	<b>41</b>
<b>FAMILY EDUCATION RIGHTS AND PRIVACY ACT (FERPA) .....</b>	<b>43</b>
<b>SCHOOL PROPERTY .....</b>	<b>45</b>
<b>OBJECTIONABLE MATERIALS POLICY.....</b>	<b>45</b>
<b>REMOVAL FROM TXVA.....</b>	<b>46</b>
<b>ADMISSION OF HOMELESS CHILDREN AND YOUTH.....</b>	<b>46</b>
<b>PARENT ACCESS TO STAFF CERTIFICATIONS .....</b>	<b>46</b>
<b>COMPLAINT RESPONSE PROCEDURE .....</b>	<b>46</b>
<b>FAMILY DIRECTORY.....</b>	<b>47</b>
<b>PARENT CONNECTIONS.....</b>	<b>47</b>
<b>SCHOOL OUTINGS &amp; STUDENT ACTIVITY CLUBS.....</b>	<b>47</b>
<b>NATIONAL MATH LAB.....</b>	<b>48</b>
<b>TECHNOLOGY ISSUES AND USAGE .....</b>	<b>49</b>
<b>INTERNET SERVICE PROVIDER (ISP) SUPPLEMENT POLICY.....</b>	<b>49</b>
<b>NETWORK ETIQUETTE .....</b>	<b>50</b>
<b>CYBER BULLYING .....</b>	<b>50</b>
<b>INTERNET SAFETY TIPS .....</b>	<b>51</b>
<b>INFORMATIONAL WEBSITES .....</b>	<b>52</b>
<b>FAQ's .....</b>	<b>53</b>
<b>K12 MY INFO .....</b>	<b>54</b>
<b>ANSWERS TO FREQUENTLY ASKED QUESTIONS.....</b>	<b>54</b>
<b>BLACKBOARD TIPS AND TRICKS.....</b>	<b>58</b>
<b>MOTIVATING STUDENTS .....</b>	<b>61</b>
<b>PARENT TIPS AND TRICKS .....</b>	<b>62</b>
<b>WORKING PARENT TIPS AND TRICKS .....</b>	<b>64</b>
<b>LIABILITY RELEASE .....</b>	<b>66</b>
<b>PHOTO RELEASE DOCUMENT .....</b>	<b>67</b>
<b>MY LOGIN INFORMATION &amp; PASSWORDS .....</b>	<b>68</b>
<b>ACKNOWLEDGEMENT OF THIS DOCUMENT .....</b>	<b>69</b>
<b>CLASS CONNECT SCHEDULE.....</b>	<b>69</b>
<b>PROGRESS/ATTENDANCE PACING CHARTS.....</b>	<b>71</b>

# TXVA ORGANIZATION CHART

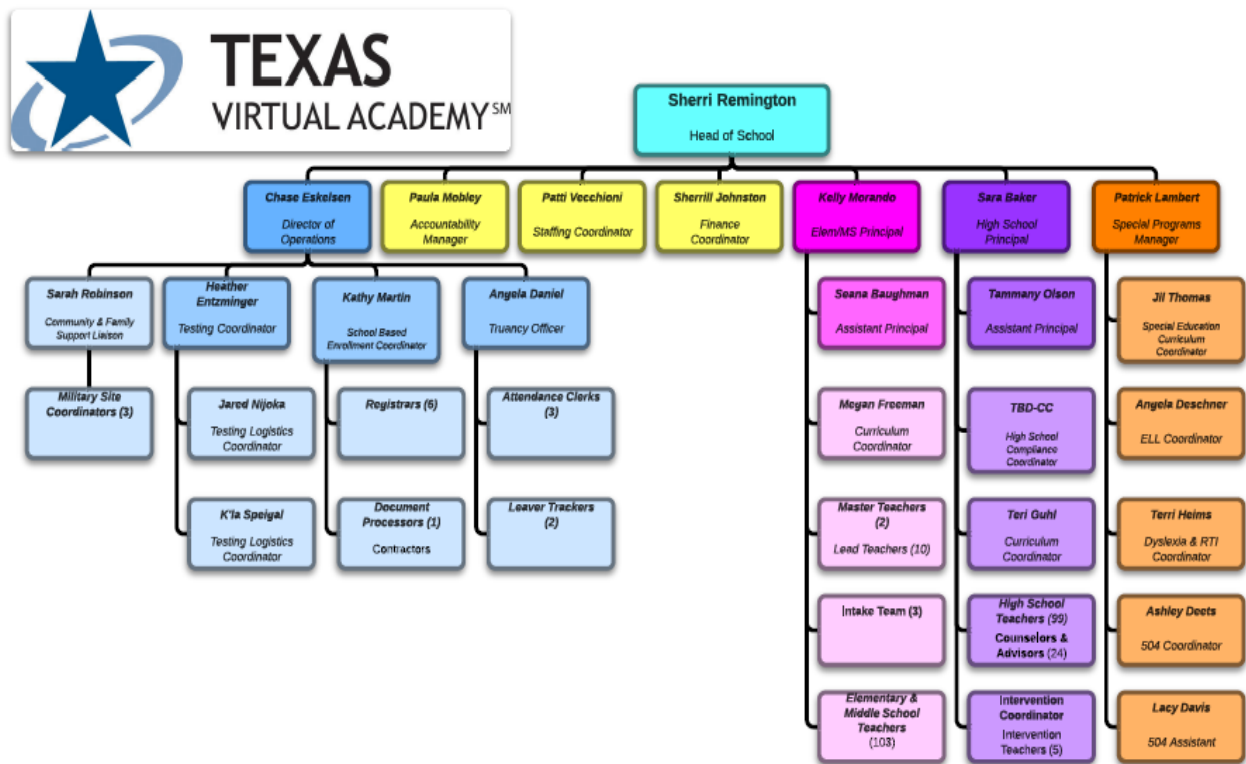

## MISSION STATEMENT

*TXVA is a partnership of families, teachers, and administrators that empowers students in a flexible learning environment with challenging curriculum, regardless of geographic, financial, or demographic circumstance.*

*Our continuing mission is to provide Texas students with an excellent education that is grounded in high academic standards, in order to help our students achieve their full academic and social potential.*

*The core philosophy of TXVA is that all young people can achieve academic excellence if they are provided rigorous instruction, high standards, informed guidance, and individual attention. Although we use the computer as a learning tool, we believe that education is primarily a human endeavour that relies on caring individuals – specifically, involved parents and committed teachers and administrators.*

# INTRODUCTION

This Parent Orientation Guide sets forth general guidance for parents and students enrolled in the Texas Virtual Academy (TXVA). TXVA operates under the Texas Virtual School Network (TxVSN) and in partnership with Responsive Education Solutions Charter Schools (RES) and is subject to the rules and regulations of the Texas Education Agency.

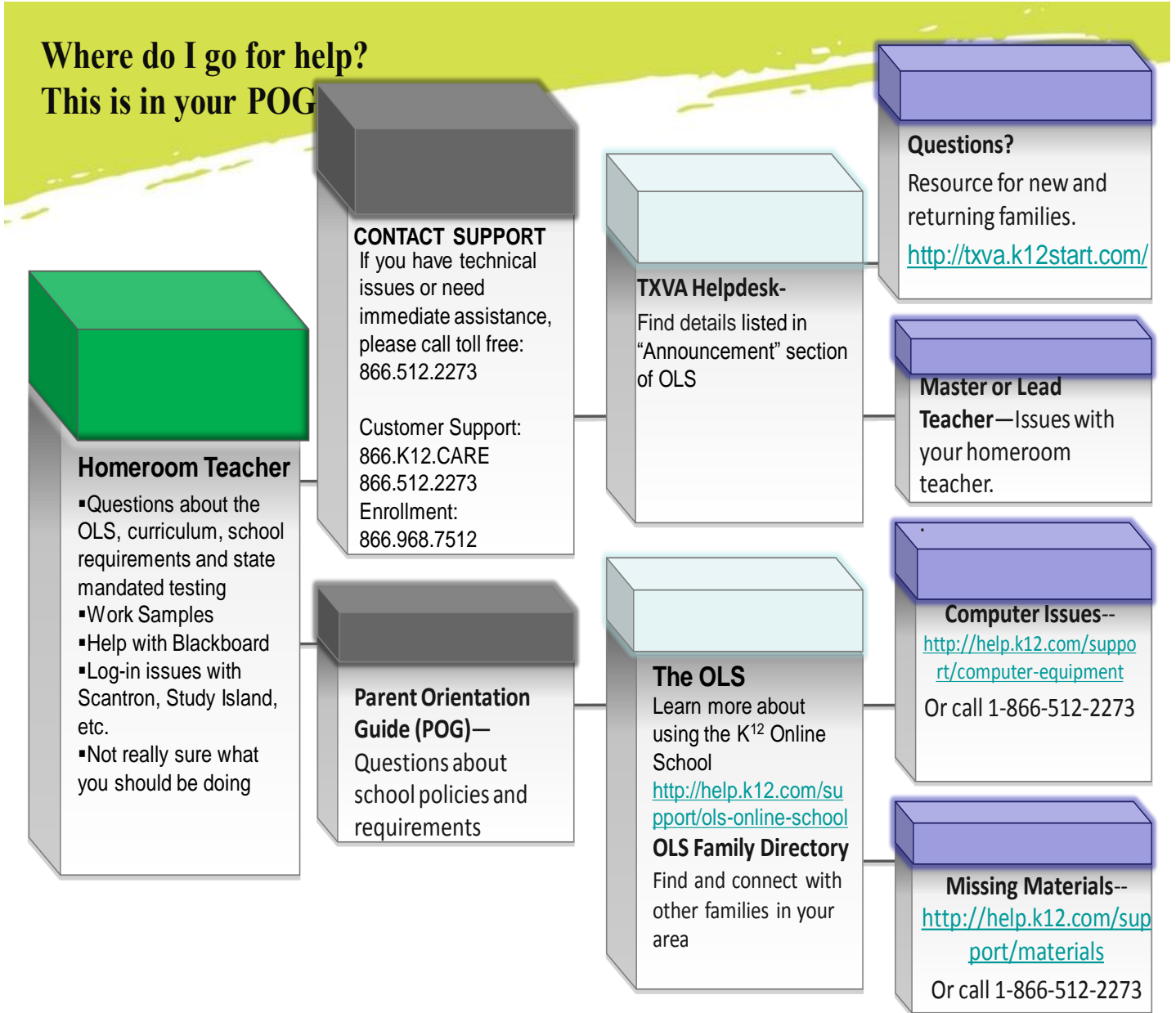

# ACADEMIC CALENDAR

August						
S	M	T	W	Th	F	S
					1	2
3	4	5	6	7	8	9
10	11	12	13	14	15	16
17	18	19	20	21	22	23
24	25	26	27	28	29	30
31						

September						
S	M	T	W	Th	F	S
	1	2	3	4	5	6
7	8	9	10	11	12	13
14	15	16	17	18	19	20
21	22	23	24	25	26	27
28	29	30				

October						
S	M	T	W	Th	F	S
			1	2	3	4
5	6	7	8	9	10	11
12	13	14	15	16	17	18
19	20	21	22	23	24	25
26	27	28	29	30	31	

November						
S	M	T	W	Th	F	S
						1
2	3	4	5	6	7	8
9	10	11	12	13	14	15
16	17	18	19	20	21	22
23	24	25	26	27	28	29
30						

December						
S	M	T	W	Th	F	S
	1	2	3	4	5	6
7	8	9	10	11	12	13
14	15	16	17	18	19	20
21	22	23	24	25	26	27
28	29	30	31			

January						
S	M	T	W	Th	F	S
				1	2	3
4	5	6	7	8	9	10
11	12	13	14	15	16	17
18	19	20	21	22	23	24
25	26	27	28	29	30	31

February						
S	M	T	W	Th	F	S
1	2	3	4	5	6	7
8	9	10	11	12	13	14
15	16	17	18	19	20	21
22	23	24	25	26	27	28

March						
S	M	T	W	Th	F	S
1	2	3	4	5	6	7
8	9	10	11	12	13	14
15	16	17	18	19	20	21
22	23	24	25	26	27	28
29	30	31				

April						
S	M	T	W	Th	F	S
			1	2	3	4
5	6	7	8	9	10	11
12	13	14	15	16	17	18
19	20	21	22	23	24	25
26	27	28	29	30		

May						
S	M	T	W	Th	F	S
					1	2
3	4	5	6	7	8	9
10	11	12	13	14	15	16
17	18	19	20	21	22	23
24	25	26	27	28	29	30
31						

June						
S	M	T	W	Th	F	S
	1	2	3	4	5	6
7	8	9	10	11	12	13
14	15	16	17	18	19	20
21	22	23	24	25	26	27
28	29	30				

July						
S	M	T	W	Th	F	S
			1	2	3	4
5	6	7	8	9	10	11
12	13	14	15	16	17	18
19	20	21	22	23	24	25
26	27	28	29	30	31	

Important Dates	
1st Day of School	8/25/14
Labor Day	9/1/14
Benchmark 1	10/6-10/10
Thanksgiving Holiday	11/26-11/28
STAAR EOC	12/1-12/5
Winter Holidays	12/22-1/2
Teacher Work Day/Student Holiday	1/16/15
MLK Day	1/19/15
Start of Semester 2	1/20/15
President's Day	2/16/15
Benchmark 2	2/9-2/13
Spring Break	3/16-3/20
STAAR	3/30-3/31
STAAR	4/21-4/22
STAAR EOC	5/4-5/8
STAAR Retest	5/12-5/13
Memorial Day	5/25/15
Last Day of School	6/3/15
STAAR Retest	6/23-6/24
STAAR EOC/TAKS	7/6-7/10

Quarters:	
1st Qtr-	Aug 25-Oct 24
2nd Qtr-	Oct 27-Jan 15
3rd Qtr-	Jan 20-Mar 31
4th Qtr-	Apr 1-June 3

Benchmarks	
1	Oct 6-Oct 10
2	Feb 9-Feb 13

## **IMPORTANT DATES**

- **August 25:** first day of school
- **August 25 – 29:** Scantron Fall Testing Window
- **September 1:** Labor Day
- **September 16:** Class Connect sessions begin
- **September 22:** Back to School events
- **October 1:** First Study Island Blue Ribbon Pathway assigned
- **October 6-10:** Study Island Benchmark Assessments
- **October 24:** End of Quarter 1
- **October 27:** Beginning of Quarter 2
- **November 1:** Second Study Island Blue Ribbon Pathway assigned
- **October 31:** Quarter 1 report cards k-mailed
- **November 26-28:** Thanksgiving Break
- **December 1:** Third Study Island Blue Ribbon Pathway assigned
- **December 22 – January 2:** Winter Break
- **January 5:** School Resumes
- **January 12 - 15:** Study Island Benchmark Assessments
- **January 15:** End of Quarter 2
- **January 16:** Teacher Work Day/Student Holiday
- **January 19:** MLK, Jr. Holiday
- **January 20:** Beginning of Quarter 3
- **January 26 – 30:** Mock STAAR tests (grades 3-5 only)
- **January 28:** Quarter 2 report cards k-mailed
- **February 1:** Fourth Study Island Blue Ribbon Pathway assigned
- **February 16:** President's Day Holiday
- **March 1:** Fifth (and final) Study Island Blue Ribbon Pathway assigned
- **March 2 - 6:** Mock STAAR tests (grades 3-5 only)

- **March 16 – 20:** Spring Break
- **March 30-April 3:** STAAR Testing (grades 3-8)
- **March 31:** End of Quarter 3
- **April 1:** last day to order above grade level courses (Math/ELA)
- **April 1:** Beginning of Quarter 4
- **April 10:** Quarter 3 report cards k-mailed
- **April 20 – 24:** STAAR Testing (grades 3-8)
- **April 28-May 8:** Remediation CC Sessions for grades 5/8
- **May 12 -13:** STAAR Re-Testing (grades 5/8)
- **May 18-22:** Scantron Spring Testing Window
- **May 25:** Memorial Day
- **June 3:** Last day of school; last day to enter attendance
- **June 12:** Final report cards k-mailed
- **June 8-19:** Remediation CC Sessions for grades 5/8
- **June 8-19:** Round 1 Grade Placement Committee meetings for 5<sup>th</sup>/8<sup>th</sup> graders
- **June 23 - 24:** STAAR Re-Testing (grades 5/8)

## **WEEKLY OPEN OFFICE WITH ADMINISTRATION**

Each week, on Mondays from 2:00-2:30, there will be an Open Office time with Kelly Morando, 3-8 Principal, and other 3-8 administrators where you can come and ask any questions you may have. The link will be posted in the weekly Trailblazer.

## **QUESTIONS OR CONCERNS?**

TXVA staff recognizes that life at school does not always run smoothly. As problems arise, school personnel and parents must collaborate to solve them. TXVA staff also realizes that parents and students do not always know what to do or where to seek out answers and often give up and become frustrated when problems remain unsolved. Please follow these procedures for general information or for assistance in resolving a problem:



- Step 1.** All concerns and issues should first be directed to the student's homeroom teacher via phone or kmail. If a TXVA teacher cannot resolve the issue, he/she directs the parent to the appropriate contact for assistance.
- Step 2.** If the concern is not resolved at this level, parents are advised to contact the Lead Teacher.
- Step 3.** If you still have questions or concerns, you may discuss them with an Administrator. Please send the Administrator a k-mail requesting a meeting or come by the principal's weekly open office hour (see "weekly open office" information above).
- 

## **ADMISSION & ENTRANCE REQUIREMENTS**

Texas Virtual Academy is currently available to most students living in Texas who qualify under the Commissioner's Rules for Virtual Schools for enrollment as required by the Texas Virtual School Network (TxVSN). To enroll in a full time virtual school program, the following criteria must be met **§70.1013**:

1. A student is eligible to enroll in a course provided by the Texas Virtual School Network (TxVSN) only if:
  - (a) the student on September 1 of the school year:
    - (1) is younger than 21 years of age; or
    - (2) is younger than 26 years of age and entitled to the benefits of the Foundation School Program under the Texas Education Code, **§42.003**;
  - (b) the student has not graduated from high school; and
  - (c) the student:
    - (1) is otherwise eligible to enroll in a public school in this state; or
    - (2) the student is a dependent of a member of the United States military, was previously in high school in this state, and no longer resides in this state as a result of military deployment or transfer.
2. A student is eligible to enroll full time in courses provided through the TxVSN only if:
  - (a) the student was enrolled in a public school in this state in the preceding school year;
  - (b) the student has been placed in substitute care in this state, regardless of whether the student was enrolled in a public school in this state in the preceding school year; or
  - (c) the student:
    - (1) is a dependent of a member of the United States military;
    - (2) was previously enrolled in high school in this state; and
    - (3) no longer resides in this state as a result of a military deployment or transfer.

Please be aware that your student(s) must be eight years old by September 1, 2014, and meet all of the required terms of participation as outlined above, to be eligible to enroll.

---

## **NEW STUDENT ORIENTATION PROGRAM**

Families new to TXVA have the opportunity to participate in a K<sup>12</sup> courses entitled *Welcome to Online Learning* and *Individualized Learning Plan: Getting Started with Scantron*. This course will appear in the student's daily plan in the Online School and needs to be the **VERY FIRST** course that the learning coach and the student complete together.

These courses are required and should be completed during the first five days of school. During the first week of school the learning coach and student will:

- Learn how to best use the Online School (OLS)
- Review daily attendance and login requirements
- Learn how to use the synchronous tool *Blackboard Collaborate*
- Complete the Reading & Math *Scantron* diagnostic assessments
- Log on to *Study Island*, K<sup>12</sup> 's test preparation program
- Receive an introduction to all courses
- Get directions on communicating with the teacher via our internal mail system called K-mail

We believe learning coaches and students will benefit greatly from participation in these K<sup>12</sup> courses. We know that the lessons will help jump start the school year so learning coaches and students will soon be swiftly soaring to success!

Students returning to TXVA will be required to complete the courses *Welcome Back to School* and *Continuing your Individualized Learning Plan*.

---

## **STUDENT CODE OF CONDUCT**

TXVA students are subject to the rules and restrictions implemented by Texas Virtual Academy and the Student Code of Conduct: Acceptable Use Guidelines for the Internet. Students enrolled in TXVA should be aware of the following guidelines and expectations. Any activity that is not listed here, which violates local, state, or federal laws, is considered a violation of the Student Code of Conduct and Acceptable Use Guidelines.

### ***Acceptable Use Guidelines for the Internet:***

- Posting anonymous messages online is not permitted unless authorized by the course's online teacher. Impersonating another person is also strictly prohibited.
- Students must use only their own user names and passwords, and must not share these with anyone.
- Students may not interfere with other users' ability to access TXVA or disclose anyone's password to others or allow them to use another user's account. Students are responsible for all activity that is associated with their usernames and passwords.
- Students should change their password(s) frequently, at least once per semester is encouraged.
- Students must not publicly post their personal contact information (address and phone number) or anyone else's.
- Students must not publicly post any messages that were sent to them privately.
- Students are not allowed to download, transmit or post material that is intended for personal gain or profit, non-TXVA commercial activities, non-TXVA product advertising, or political lobbying on a TXVA owned instructional computing resource.
- Students may not use TXVA instructional computing resources to sell or purchase any illegal items or substances.
- It is not allowed to upload or post any software on TXVA instructional computing resources that are not specifically required and approved for student assignments.

### ***Inappropriate Behavior:***

- Insults or attacks of any kind against another person.
- Use of obscene, degrading, or profane language.
- Harassment (continually posting unwelcome messages to another person) or use of threats.
- Posting material that is obscene or defamatory or which is intended to annoy, harass or intimidate another person. This includes distributing “spam” mail, chain e-mail, viruses, or other intentionally destructive content.

TXVA reserves the right to review any material transmitted using TXVA instructional computing resources or posted to an TXVA instructional computing resource to determine the appropriateness of such material. TXVA may review this material at any time, with or without notice. E-mail transmitted via TXVA instructional computing resources is not private and may be monitored.

TXVA assumes no responsibility for information obtained via the Internet, which may be illegal, defamatory, inaccurate or offensive. TXVA assumes no responsibility for any claims, losses, damages, costs, or other obligations arising from the use of instructional computing resources. TXVA also denies any responsibility for the accuracy or quality of the information obtained through user access. Any statement, accessible on the computer network or the Internet, is understood to be the author’s individual point of view and not that of TXVA, its affiliates, or its employees. TXVA assumes no responsibility for damages to the user’s computer system.

Nothing in this policy negates any obligation the student and Learning Coach have to use the instructional computing resources as required in the Use of Instructional Property Agreement ("Agreement") the Learning Coach or guardian signed as part of the student's enrollment packet. In the event that this Code conflicts with the Agreement, the terms of the Agreement shall prevail.

***Violation Consequences:***

- Removal of student access to TXVA instructional computing resources, which could result in his/her inability to complete learning activities.
- Suspension or expulsion from TXVA.
- Involvement with law enforcement agencies and possible legal action.

TXVA administration reserves the right to update or alter this agreement at any time. Such revisions may substantially alter access to TXVA instructional computing resources. TXVA instructional computing resources include any computer, software, or transmission system that is owned, operated, or leased by TXVA.

---

## **EXPECTATIONS**

**Serving as the learning coach is a full-time job.** TXVA’s program is challenging. Parents of students in grade 3 through 8 can expect to work with their student six hours per day in addition to lesson planning to maintain a typical school year’s pace for accomplishing lessons associated with assigned grade levels. The Online School® and its curriculum have the flexibility that allows for students to be challenged according to their mastery of skills. Most students spend between 25 and 50 percent of their day actually online and the remainder of their time working off line completing assignment in workbooks, printed lessons, or other related activities.

TXVA has chosen the K12<sup>®</sup> curriculum because it is designed to help children exceed state, national and international standards.

Lesson planning, materials preparation, progress planning, teaching and the administration of a student's day-to-day education are both exciting and challenging. All of these things require parental commitment to the discipline and organization implicit in the skills needed to manage a first-class education.

Please read the "I Understand and Agree" statements below very carefully as these expectations should be a part of each parent's calculation of commitment as a TXVA parent. While these expectations were included in the application packet, now is a good opportunity to revisit that commitment.

---

## **I UNDERSTAND AND AGREE**

The purpose of this "I Understand" section is to set expectations for TXVA parents. Student success is a primary goal of TXVA and that can only be achieved if you, the parent, are successful. To be successful it is important that parents of TXVA students understand and are in agreement with the following curricular and attendance requirements:

- ❖ I understand that my student is enrolled in a public school with attendance requirements that I am expected to meet. The state requirement is an average of 6 hours per day. Please see the Instructional Time section of the Parent/Student Handbook for more information. Students who have poor attendance (insufficient hours recorded over time in the system) may be referred to the juvenile courts system as a truant student in need of supervision.
- ❖ I accept the responsibility to supervise my student in using the K12<sup>®</sup> curriculum, and I understand that I am expected to become knowledgeable about it. Any other work accomplished by the student is supplemental to, and not in place of, the K12<sup>®</sup> curriculum lessons. TXVA does not consider it acceptable to leave a student home alone or unsupervised to complete coursework.
- ❖ I understand and agree that student progress is an expected part of the TXVA program in addition to the hours logged, and that my student is expected to complete the work of one grade level in one academic year. I understand that my student should be completing 3% progress each week in each subject. I am committed to ensuring that my student meets this expectation.
- ❖ I understand and agree that I am expected to follow the guidance and support of a certified teacher in implementing the TXVA program with my student.
- ❖ I understand and agree that I am expected to participate in regular conferences and meetings with my student's teacher, and that I must submit work samples as required.
- ❖ I understand and agree that, as students in a public school, TXVA students are required to participate in state testing, Scantron testing and Benchmark testing. I understand my child is expected to fully participate in the testing at his/her enrolled grade level and that I am required to provide transportation to all testing sites regardless of distance.

- ❖ I understand and agree that it is my responsibility to secure an Internet service provider and that I am reimbursed according to the school policy and compliancy with the program, as described in this handbook.
- ❖ I understand that my child must have a working microphone at all times in order for her/him to participate in data conferences, Class Connect sessions, tutoring sessions, and Study Hall.
- ❖ I understand and agree that TXVA is a full-time public school program and that my student may not be enrolled in any other full-time or part-time school.
- ❖ I understand that if my child receives special services, they may not be provided in the home and I must provide transportation to those services.

## **ACADEMIC INTEGRITY POLICY**

All work submitted and/or marked complete in the OLS is assumed to have been completed only by students from their own student account. Students should not have access to the learning coach login credentials. Students are also responsible for observing the standards on plagiarism and properly crediting all sources relied on in the composition of their work. Failure to abide by these standards will be reported to the 3-8 Principal and will result in a conference with the student's parent and/or Learning Coach. Students who violate this policy are subject to the following consequences.

### **Consequences**

- 1<sup>st</sup> offense- Redo assignment, student placed on Action Plan
- 2<sup>nd</sup> offense- Redo assignment, no credit for initial assignment, may not promote from course(s) without more proof of mastery through work samples or conference sessions (via Blackboard Collaborate)
- 3<sup>rd</sup> offense- Expulsion

### **Plagiarism**

The definition of plagiarism is: Copying or imitating the language, ideas, and thoughts of another writer and passing them off as your own original work. Specific examples of plagiarism that is not tolerated are:

- Copying or rephrasing another student's work.
- Taking material from Internet sources and using it as your own, even if some words are changed.
- Having someone else write an assignment or rephrase any part of an assignment (not just proofread it).
- Directly copying student aids (for example, CliffsNotes), critical sources, or reference materials in part or in whole without acknowledgment.
- Indirect reproduction of student aids, such as CliffsNotes, Coles Notes, critical sources, or reference materials by rephrasing ideas borrowed from them without acknowledgment.

### **Source Citation**

Many courses require written work in which students need to cite sources. Any direct quotations from a textbook can simply be cited as (Author, Page Number). Any quotations from outside

sources require full citations, including author, title, publisher, date of publication, and page number. If a student cites information found on a Web site, he/she provide the complete Web page or site title, URL, author if known, page number if applicable, and publication date of the site, if available, and date of access.

---

## **COURSE WORK**

Students should work at the pace of 3% progress per week. If a student in grade 3-7 completes a math or language arts course prior to April 1<sup>st</sup>, the next math or language arts course will be ordered for that student once the teacher confirms satisfactory completion of the current course. This is not the case for 8<sup>th</sup> grade students, as high school credit courses cannot meet the “seat time” requirements if they are started that late. If a student receives a new course, that course is to be completed at the rate of 3% progress per week. It is not considered a “bonus” course that students can just work on as they choose to.

---

## **COMPLIANCY PLAN/ACTION PLANS**

Families who enroll their children in the Texas Virtual Academy agree to the “I Understand” statements listed in this Parent Orientation Guide. These expectations represent the basic minimums to which parents and students must comply in order to experience success in the Texas Virtual Academy. The POG is sent to parents in kmail and the timestamp noted when the kmail is open will be considered as the parent’s agreement to the “I Understand” statements.

The vast majority of families who enroll with the Texas Virtual Academy consistently and conscientiously comply with these expectations. However, as the school year progresses, some families may demonstrate the inability or unwillingness to fulfill one or more of the “I Understand” statements.

In the event that a student is non-compliant with school expectations, his/her continued enrollment is in danger and the teacher will implement an Action Plan as an attempt to get the student on track and avoid withdrawal from the program. Students may also be referred to the Compliance Committee. Parents who do not attend the initial required meeting with the Compliance Committee will result in their student being administratively withdrawn from TXVA.

It is the goal of the Texas Virtual Academy to partner with parents in order to ensure that all students are successful and the school remains compliant with state and local requirements. If there is no response to this attempt to resolve the student’s non-compliance within the provided timeline on the Action Plan, we will unfortunately proceed with the administrative withdrawal.

---

## **INSTRUCTIONAL TIME**

Texas statute requires all public schools offer a minimum of one-hundred-eighty (180) days of instruction. Additionally, TXVA requires an average of 6 hours of instructional time per day. For a student to receive credit, TEC §25.092 requires that a student be in attendance 90% of the scheduled school days. This attendance requirement is prorated for students enrolling after

August 25, 2014. Your teacher will help you develop a weekly schedule to ensure that your student meets this requirement.

TXVA students may log instructional time anytime during the day and on any day of the week between the first day of school, August 25, 2014, and the last day of school on June 3, 2015. Students are required to school through June 3, 2015. Any requests for a student to finish the school year early, must be approved by the Principal. Attendance cannot be logged after June 3, 2015. Instructional time must directly relate to lesson objectives which are aligned to the standards set forth in the Texas Essential Knowledge and Skills (TEKS).

---

## **ATTENDANCE & TRUANCY POLICY**

Texas Virtual Academy has the responsibility to enforce Texas Compulsory Attendance Laws. Compulsory attendance applies to students who are at least six years old as of September 1<sup>st</sup> of the applicable school year. The law requires a student to attend a Texas public school until the student's 18th birthday, unless the student is exempt under §25.086. This requirement is enforced through §§25.093 and 25.094. The educational program offered by TXVA is predicated upon the presence of the student and requires continuity of instruction and participation in virtual instructional sessions. It is mandatory that all TXVA students in grades 3-8 log progress in the Online School (OLS) and grades 9-12 complete assignments in the Learning Management System (LMS) daily, for a minimum of six (6) hours per day in order to meet school attendance requirements.

Such participation is documented by Learning Coaches. Attendance is mandatory of all students enrolled in the school during regular school days whether working in online coursework or offline assignments, and/or at Elluminate sessions to which s/he has been assigned to attend.

Attendance for TXVA students is accounted for in the following ways:

1. Student working in coursework whether on or offline in the Online School (OLS) or Learning Management System (LMS);
2. Student participation in assigned virtual online sessions with state-certified teachers.

Attendance credit will be submitted for each approved student to the Texas Education Agency two ways: full day present or full day absent. Full day present and full day absent are determined based on the total minutes below, which are logged by the Learning Coach:

Attendance Credit Chart

Grades 3-8:

*360 minutes or greater daily = Full day present*

Grade 9-12:

*360 minutes or greater daily = Full day present*

Excused Absences

When a parent/legal guardian knows that their student will be absent, it is requested that the parent/legal guardian give the school prior written notice of the upcoming absence.

Texas Virtual Academy considers the following factors, as defined by Texas Education Agency (TEA), to be a “reasonable” excuses and will result in an “excused absence” for time missed from school:

- Personal illness (a written physician’s statement verifying the illness may be required);
- Observance of a religious holiday;
- death in the immediate family; shall mean: parents, legal guardians, spouse, brothers, sisters, children, grandparents, parents-in-law, brothers-in-law, sisters-in-law, aunts and uncles;
- Family emergency; circumstances which cause reasonable concern to the parent or legal guardian for the safety or health of the student (the reasonableness of the parent’s or legal guardian’s concern is subject to evaluation by the Head of School, Head of School’s designee, on a case-by-case basis);
- Other situations beyond the control of the student as determined by the Head of School, Head of School’s designee, on a case-by-case basis, including, but not limited to, homelessness and its attendant difficulties.

When it is necessary for a student to be absent, it is the parent’s responsibility to call or kmail the student’s assigned Attendance Clerk. The Attendance Clerk will forward that information to the appropriate Homeroom Teacher.

#### Required sessions

Failure to attend required Class Connects, intervention, Target Teach, remediation or tutoring sessions is considered absence from school and may result in truancy being filed.

#### Accumulated Unexcused Absences

Students who do not attend required online sessions, or fail to log attendance within the Online School when required will be considered absent for the required amount of time unless a valid written excuse is provided to the Attendance Clerk. Absences not identified as “reasonable” above will be considered “unexcused”. Families who fail to log a full day in the Online School are subject to unexcused absences (see *Attendance Credit Chart* above). A student is deemed truant when he/she is absent from school without an acceptable excuse when three (3) unexcused absences are accumulated. The parent/legal guardian must submit a Dr.’s note or a written excuse for absences that are deemed as excused. (See 1-7 under excused absences).

(3) Unexcused Absences: Students who accumulate a total of three (3) absences will be sent a warning letter via personal email/k-mail by their Attendance Clerk.

(5) Unexcused Absences: Students who accumulate a total of five (5) absences will be sent an invitation to attend a Truancy Mediation Hearing via personal email/k-mail. Parents and students (if necessary) will be required to attend a meeting with school personnel in Blackboard Collaborate, which is subject to include; teachers, Administrators, Truancy Officer, and anyone else designated by the Head of School, to discuss the absences and a truancy plan for improvement.

(10) Unexcused Absences: After a total of ten (10) or more total absences are accumulated for any student truancy charges will be filed at the student or parent’s local court.

In the event that a TXVA student’s chronic truancy results from homelessness, the student’s enrollment rights at TXVA shall be based on the McKinney-Vento Homeless Assistance Act, 42 U.S.C. 11431 et seq., and the Texas Education For Homeless Children Act Sec 721.

---



# TRUANCY PROCESS

**(3) Absences  
Unexcused**

A warning letter is **e-mailed and k-mailed** to parents with a personal phone call from an Attendance Specialist.

**(5) Unexcused  
Absences**

A warning letter is **e-mailed and k-mailed** to parents with a personal phone call from an Attendance Specialist. Attendance Specialist will also send an invitation to attend a mandatory Truancy Mediation Hearing via e-mail and k-mail to parent/legal guardian.

**(8) Unexcused  
Absences**

Truancy Officer will contact parent/legal guardian to prevent truancy charges being filed if 10 days of unexcused absences are reached.

**(10) Unexcused  
Absences**

Truancy Officer will file truancy charges with local court.  
Parent will be emailed.

**Truancy  
Mediation  
Hearing**

During the Mediation Hearing the reason for excessive absences and the importance of student's attendance will be discussed. The attendance laws will be reinforced and parent/legal guardian and student will sign a Mediation Agreement.

**If Mediation Agreement is not adhered to, truancy filings will begin.**

- ⦿ NOTICE TO APPEAR FOR MEDIATION – Sent at 5 days of unexcused absences
- ⦿ COMMITMENT TO MEDIATE
- ⦿ SIGN MEDIATION AGREEMENT

**Follow-up**

Attendance Specialist and homeroom teacher will closely monitor student's attendance, making personal contact and fosters a positive relationship with parents. If AP is not adhered to, Attendance Specialist will escalate to Truancy Officer to begin filing truancy charges with local court.

## **ATTENDANCE FAQs**

### **1. When can I log attendance?**

You are able to log attendance from your first day of school, your assigned School Start Date, August 25, 2014, until the last day of school, June 3, 2015.

For Grades 3-8, attendance must be logged in the LC's account daily in the Online School (OLS); HS attendance must be marked daily by the LC in the Online School and in the **Learn Management System (LMS)** by the student. Please see below important attendance (truancy) information:

- On the student's 3<sup>rd</sup> absence you will receive an email/kmail and a personal call from your Attendance Specialist.
- On the student's 5<sup>th</sup> absence you will receive an email/kmail advising you of the absence. As a truancy prevention measure, you will receive a notice for a mandatory online mediation hearing with your Attendance Specialist (via Blackboard Collaborate) to address the reasons for the excessive absences (TEC 25.095(2)). At that time you will be required to sign a mediation agreement (plan) to avoid any additional absences.
- On the student's 8<sup>th</sup> absence you will receive a phone call from the Truancy Officer as a reminder not to accumulate any additional absences.
- On the student's 10<sup>th</sup> absence, the law requires that court action be taken (TEC 25.0951). At that time truancy proceedings will begin. Filing will take place in your local court and you will be required to appear before the judge and may be subject to a fine.

### **2. What attendance requirements do I need to fulfill by June 5, 2015?**

Your child needs to have 180 days AND 1080 hours of attendance logged by the last day of school.

### **3. What if my child exceeds the required attendance hours?**

Your child is encouraged to attend school above the required attendance hours, but not required to. A minimum of six hours must be logged daily in order for a student to be counted present for the school day. Less than six hours logged will result in accrual of unexcused absences.

### **4. Where do I need to log my child's attendance and how often?**

Student attendance hours are logged on the attendance screen in the parent's OLS and must be entered daily. At no time should a student be entering his/her own attendance.

### **5. Why should I log attendance?**

In addition to meeting the legal attendance requirements for TXVA, logging attendance provides you and your child with a log of the work accomplished and is a required as TXVA is a Texas public school.

### **6. What are supplemental hours?**

Provided you complete your K12 coursework first, attendance time may be logged for activities in which your student engages that relate to the course objectives. Please contact your teacher before entering supplemental attendance time to ensure the additional activity you wish to include satisfies course objectives.

**7. What should I do if I forgot to log my child’s supplemental hours?**

Contact your teacher and he/she will assist you in logging supplemental hours.

**8. How many hours should my child log if they enrolled after the start of school?**

Hours are prorated based on a student’s start date. Students who start after the first day of school should follow the daily or weekly attendance guidelines outlined in the Instructional Time section of this Parent/Student Handbook

**9. Do I log attendance for the actual time the lesson took or just the default time that comes up on the OLS?**

You must log the actual amount of time it took for the student(s) to complete the lesson(s) each day. If you consistently observe your student(s) complete lessons before he/she accumulates the required amount of time, you may benefit from setting a time limit to each subject rather than just expecting one lesson per day. From the landing page you will click the word “Attendance”

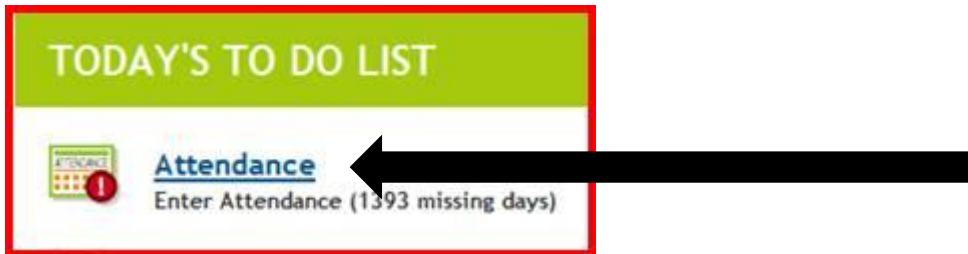

When you click “Attendance”, an additional screen will appear. In the top right corner of the screen you will see how many missing days you have:



When you click “View” next to missing days, all of the dates will appear that attendance has not been logged for. You will need to select the date and log hours for that particular date. **You should never see any days of missing attendance.**

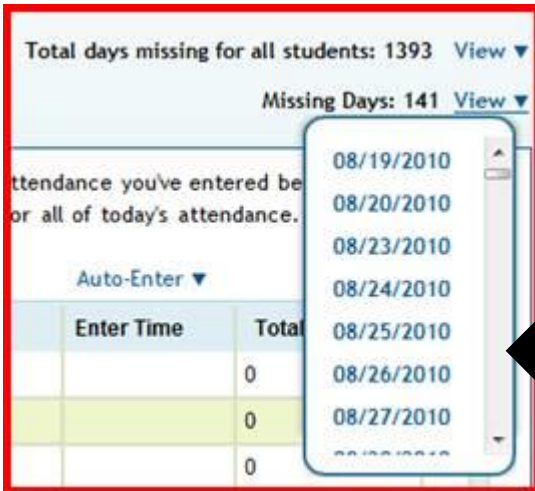

The system will now display alerts on your account for missing days and hours:

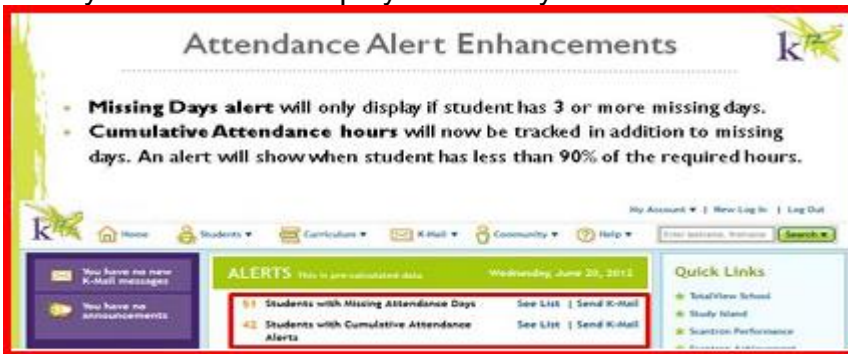

**10. If I am absent, who do I send my absence notification to?**

You would send your absence notification to your Attendance Specialist and Homeroom Teacher.

**11. Where do I send doctor's notes or excused absence notes to?**

Doctor's note should be kmailed to your Attendance Specialist and kmailed to your Homeroom Teacher.

## STUDENT RECORDS

Student records are maintained at the TXVA office. Parents/legal guardians may contact the TXVA office to obtain a copy of student records. A copying fee may be assessed. If parents change their address, telephone, e-mail address, or place of employment, they are asked to follow the procedure below. Parents are responsible for keeping contact information current within the account setup section of the OLS®.

## **CHANGE OF CONTACT INFORMATION**

### **Mailing Address**

In the event your address is different and needs to be changed, TWO new proofs of residence are required in order to update your address in the K12 and state systems. TXVA will need two of the documents listed below. Once these documents have been submitted, our administrative office will be happy to update your new address.

To confirm your address please follow the steps below:

Log into the OLS with your username and password;  
Click “My Account” at the top right of your screen;  
Select “My Account” from the drop down menu;  
Your address will appear.

Please submit two of the following documents as new proofs of residence:

- Mortgage Statement;
- Lease;
- Utility Bill (gas, water, or electric) – must show service address;
- Property Tax Statement;
- Texas Driver's License or Texas ID with new address on it;
- Internet/Phone/Cable Bill – must show service address. If you have a bundle service, please submit your entire bill to ensure the proper information is received.

Please ensure the proofs of residence are in the name of the parent/guardian, otherwise the documents will not be accepted.

If the proofs of residence you are submitting are not in your name, you will need to fill out a form and have it notarized (contact school office for the form). You will send this notarized form in with your two new proofs of residence.

Please fax these two new proofs of residence to 1.888.506.6777. Attn: Address Change

If you have any questions regarding your address change, please send a k-mail to your appropriate grade level registrar. Your homeroom teacher will be able to tell you the name of your appropriate grade level registrar. You may also contact the TXVA Administrative Office at 972-420-1404, Monday-Friday from 8:00am-4:30pm if you have additional questions.

### **Email Address and Phone Number**

This can be done by parents in the “My Account” area under “My Info” in the Online School.

---

---

The screenshot displays the K12 TotalView School website interface. At the top, there are navigation tabs: Home, Plan, Progress, Courses, Community, and Help. Below these is a 'TODAY'S TO DO LIST' for Thursday, July 10, 2014. A 'Quick Links' section contains a 'My Info' link circled in red. The main content area shows a 'My Info' section with a 'My Account' button also circled in red. To the right, a 'My Account' form is visible with fields for Username, Password, Verify Password, Security Question (Name of your school?), Security Answer, Email, and Home Phone. The Email and Home Phone fields are circled in red. The footer contains the copyright notice: Copyright © 2014 K12 Inc. All rights reserved. K

---

## WITHDRAWALS

If a parent wants to withdraw from TXVA, they should contact their homeroom teacher to begin the withdrawal process. The teacher will work with the family and possibly refer them to other administrators to speak with before withdrawing. Once the withdrawal has been confirmed with the parent, the TXVA office will email a form to the parent's personal email address to be completed and returned. Once the forms are received, the registrar will request final grades from the homeroom teacher who will then submit those to the registrar and the withdrawal will then be completed. Due to Texas law, which states withdrawals can only be processed during the academic year, withdrawal requests received after the last day of school will be accepted immediately and officially processed on the first day of school the following school year.

---

## ACADEMIC ADVANCEMENT

Due to the design of the linear calendar, students in a traditional school are expected to progress at the same rate during the one-hundred-eighty day (180) school year. High-performing students may be held back and low-performing students may be left behind. All students are presented the same lesson at the same time. Students are often not required to master the lesson objectives before advancing to the next grade level. Advancement of students before they are ready may result in gaps or deficiencies of knowledge that is essential for success in the next subject level.

Pursuant to the Student Success Initiative, TXVA must notify students and parents of mandatory state testing requirements. As part of the Student Success Initiative, fifth grade and eighth grade students must meet the expected standard on the STAAR Reading and the STAAR Math assessments to be promoted to the next grade level.

Your teacher will review the STAAR testing dates with you. The very firm expectation for TXVA is that your student will attend the STAAR testing on the given dates. Please review the Academic Calendar and Important Dates sections to see all testing dates.

It is important to understand that the decision to advance a student to the next course or grade level is made jointly by the parent and teacher and focuses on what is in the best interest of the child. Academic achievement through content mastery is the cornerstone of the Texas Virtual Academy and the K12<sup>®</sup> curriculum. TXVA understands that children do not learn at the same rate or in the same manner. The program offers families flexibility in scheduling and instructional strategies. TXVA focuses on mastery of lesson objectives, encouraging families and students to spend the time needed daily and throughout the year to reach mastery of most lesson objectives.

Decisions to advance in a course level are made jointly by the parent and teacher at any time of the year. Advancement of a student from one course level to the next requires the approval of an administrator, who will complete the actual course promotion. Students are required to master at least 90% of the course objectives before advancing to the next course level. This approach results in a solid foundation of core knowledge essential for success in the next subject level.

It is the goal of TXVA to allow students to advance in Math and/or Language Arts at any time of the year up to April 1, 2015. Students cannot begin a high school course after September 8, 2014, unless they enroll mid-year and show documentation that the first semester of a high school course has been completed/started. Parents and teachers evaluate every student's course level and grade level prior to the conclusion of the current school year. This evaluation does not affect math and English/language arts course level changes, which can be made at any time up to April 1, 2015. Together, the TXVA teacher and parent arrive at a decision on the advancement of the student. Advancement of a student from one course level to the next requires the approval of a Lead or Master Teacher. *Sufficient progress in all courses is expected before course level advancement in one area may be considered.* **Students may only advance course levels in Math and/or Language Arts.** Course level advancement in other

courses will not be permitted. If a student is not on track with progress in any other subject, course level promotion requests will not be approved.

---

## **MANDATORY TESTING INFORMATION**

**Attendance is mandatory at all TXVA testing events.** Parents must ensure that students participate in all required state and local testing. This testing includes but is not limited to Scantron and Study Island benchmarks (either online or in person) and all STAAR testing. Parents are responsible for transportation to and from all testing, regardless of distance. Please note that pursuant to House Bill 5, 8<sup>th</sup> graders who are taking the high school credit Algebra I and/or English I courses will be required to take the Algebra I and/or English I EOC exams rather than the 8<sup>th</sup> grade STAAR Math and Reading exams.

Lack of participation in required testing may result in failing grades and may place the student's continued enrollment at risk. If a student misses any testing (Scantron, benchmarks, STAAR), the student will receive a zero for participation. A doctor's note will be needed for missed STAAR testing. Students who choose to not attend testing will be referred to TXVA's Compliancy Committee. Vacations, holidays, and/or doctor's appointments cannot be scheduled during testing dates.

Please read over the K<sup>12</sup> Testing Family Guide to State Testing which will be kmailed to families in early October or upon enrollment.

### **STAAR Tests by Grade Level**

Grade	Reading	Math	Writing	Science	Social Studies
Third Grade	YES	YES			
Fourth Grade	YES	YES	YES		
Fifth Grade	YES	YES		YES	
Sixth Grade	YES	YES			
Seventh Grade	YES	YES	YES		
Eighth Grade	YES	YES		YES	YES

### **STAAR Testing Weeks**

\*Do not schedule any vacations or appointments during these weeks!



- **March 30-April 2:** STAAR Testing (grades 4, 5, 7, 8)
  - **April 20 – 24:** STAAR Testing (grades 3-8)
  - **May 12 -15:** STAAR Re-Testing (grades 5/8)
  - **June 23 - 26:** STAAR Re-Testing (grades 5/8)
- 

## **SCANTRON**

All students will take two sets of Scantron Performance Assessments during the school year. Students will test in Math and Reading at the beginning and at the end of the school year. Scantron Performance Assessments are computer adaptive tests to be given in your home through a secure website. You will be kmailed your child's login information. The purpose of these tests is to provide your teacher with information on your child's strengths as well as areas which need additional focus this school year. All students should have their first assessments completed within one week of the start of the school year or their enrollment date if enrolled after the first day of school. The end-of year exam must be completed before the student finishes the school year. Beginning and end-of-year Performance Assessments will be compared, and a growth score will be determined. Your teacher will share this information with you after the tests are taken. Scantron tests are **not** optional. All students in all grades are **required** to take these tests. **Students who do not take the assessments may have their curriculum locked until the assessments have been completed and an Action Plan may be started.**

If your student has any accommodations from a 504 or IEP, please be sure that you provide those during Scantron testing.

**Please note that you will need to use one of the following browsers so that the test can be scored: Internet Explorer 8 OR Mozilla Firefox Version 3.6.28. It is important to turn your pop-up blockers off and also always clear your cache and delete your cookies in between each assessment. Updated browser information will be sent via kmail if that information changes.**

---

## **STUDY ISLAND**

Throughout the year, students will participate in Benchmark exams in Study Island (online test preparation program). There will be two required benchmark exams for students the weeks of October 6, 2014 and January 12, 2015. The results of these and all other assessments will allow parents and teachers to work as partners in developing the best academic path for students. Students are also expected to work in this program on a daily basis and complete assigned lessons in order to both strengthen and build skills. Teachers will often use the Study Island program during Class Connect, Target Teach and tutoring sessions. Students taking HS level

Math &/or ELA will not be required to complete their grade level SI assignments for that subject area

**Students who do not complete these assessments will receive a 0% for their grade. Failure to participate in these assessments may result in the student being required to attend mandatory tutorials, interventions or Class Connect sessions.**

One of our TXVA learning coaches shared their family's procedure for incorporating the monthly Study Island pathways into their routine:

- 1) First, I set up a 3-ring binder for the pathway, with a section for each subject.
- 2) For each lesson, I print out all the lesson pages and a 15-question practice sheet.
- 3) Each day, I have my student pick two areas to study then try the practice sheet.
- 4) Together we go over the practice sheets, correcting them as we go, working together from the lesson printouts.
- 5) When we finish with a lesson, we go to Study Island and the student works on earning the Blue Ribbon by him/herself. (If your student has any testing accommodations from a 504 or IEP, please be sure to use those while working in Study Island.)

---

## **GRADING POLICY & REPORT CARDS**

TXVA issues formal report cards every nine weeks. The final report card will be issued in June. Teachers will post all grades in the online grade book. Parents will have a login for this online grade book and will be able to access student grades at any time. The final grade in each content subject, including electives, is determined by OLS progress from each reporting period, participation in all required school assessments, attendance to required Class Connects, and work samples. *If students do not participate in the assessments, they may not receive credit for the course, and promotion to the next grade level may be impacted.*

The final grade for non-core courses is based on cumulative progress recorded in the Online School as well as work samples. One of the many features afforded by the Online School<sup>®</sup> is a current report of a student's academic progress and attendance information. A parent may log on to the system at any time and view this information.

To be promoted to the next grade, the student must meet the Texas Student Success Initiative requirements for that grade. Additionally, the student must have a final average of 70 or above in at least three core content courses. Students who fail **two or more core courses** with one being math or ELA may be retained. If a parent would like to request retention and the teacher does not agree, a Grade Placement Committee meeting will need to be held.

**For each reporting period, the grade in a content area subject is comprised of the following:**

## **Grading for Students for Grades 3-5:**

### **For Quarters 1, 3, 4:**

#### **For Science (3/4), Social Studies (3-5), and Art, Music, PE, and Health (3-5):**

- 80% OLS progress
- 20% Work Samples

#### **For Math (3-5), ELA (3-5) and Science (5) for students who ARE required to attend CC sessions:**

- 40% OLS progress
- 20% Testing
- 10% Work Samples
- 10% Study Island Blue Ribbons
- 20% Class Connect Attendance

#### **For Math (3-5) and ELA (3-5) for students who are NOT required to attend CC sessions:**

- 60% OLS progress
- 20% Testing
- 10% Work Samples
- 10% Study Island Blue Ribbons

***\*There are 2 different grading procedures based on if a student is taking a STAAR test in that subject area this year or not, since 20% of their grade is based on Testing (score & participation).***

### **For Quarter 2 (based on no testing):**

#### **For Science (3/4), Social Studies (3-5), and Art, Music, PE, and Health (3-5):**

- 80% OLS progress
- 20% Work Samples

#### **For Math (3-5), ELA (3-5) and Science (5) for students who ARE required to attend CC sessions:**

- 60% OLS progress
- 10% Work Samples
- 10% Study Island Blue Ribbons
- 20% Class Connect Attendance

#### **For Math (3-5) and ELA (3-5) for students who are NOT required to attend CC sessions:**

- 60% OLS progress
- 20% Work Samples
- 20% Study Island Blue Ribbons

## **Grading for Students for Grades 6-8:**

### **For Quarters 1, 3, 4:**

#### **For Science (6/7), Social Studies (6/7), and Art, Music, PE, and Health (6-8):**

- 80% OLS progress
- 20% Work Samples

#### **For Math (6-8), ELA (6-8), Science (8), and Social Studies (8) for students who ARE required to attend CC sessions:**

- 40% OLS progress
- 20% Testing
- 10% Work Samples
- 10% Study Island Blue Ribbons
- 20% Class Connect Attendance

#### **For Math (6-8) and ELA (6-8) for students who are NOT required to attend CC sessions:**

- 60% OLS progress
- 20% Testing
- 10% Work Samples
- 10% Study Island Blue Ribbons

### **For MS World Language (6-8):**

100% Progress in the MS World Language Course

*\*Please note that the "Grade to Date" in the MS World Language course is not the reported grade. This grade is determined by percent progress complete.*

***\*There are 2 different grading procedures based on if a student is taking a STAAR test in that subject area this year or not, since 20% of their grade is based on Testing (score & participation).***

### **For Quarter 2 (based on no testing):**

#### **For Science (6/7), Social Studies (6/7), and Art, Music, PE, and Health (6-8):**

- 80% OLS progress
- 20% Work Samples

#### **For Math (6-8), ELA (6-8), Science (8), and Social Studies (8) for students who ARE required to attend CC sessions:**

- 60% OLS progress
- 10% Work Samples
- 10% Study Island Blue Ribbons
- 20% Class Connect Attendance

#### **For Math (6-8) and ELA (6-8) for students who are NOT required to attend CC sessions:**

- 60% OLS progress
- 20% Work Samples

20% Study Island Blue Ribbons

**For MS World Language (6-8):**

100% Progress in the MS World Language Course

*\*Please note that the “Grade to Date” in the MS World Language course is not the reported grade. This grade is determined by percent progress complete.*

\*We do have an exception to this grade scale, however. If a student (8th grader) is taking a HS course, the grade for that subject will be determined by that HS teacher, and the scale above will not be used at all for that subject.

If ARD committee decides upon a different grading scale for a student’s IEP, that grading scale will be used in place of the one outlined above.

**3-8 Grading Scale for Grades 3-8 for Math, ELA, Science, and Social Studies:**

- A = 90-100%
- B = 80-89%
- C = 70-79%
- F = 69% or below

**3-8 Grading Scale for NON-CORE courses (Art, Music, PE, and Health) will be reported with a Pass or Fail:**

- P = 70-100%
- F = 69% and below

**6-8 Grading Scale for NON-CORE World Language courses (Spanish I, Spanish II, French I, French II) will be reported with a Pass or Fail:**

- P= 90-100%
- F= 89% and below
  - *Grading for this course is based on progress alone. The percent progress complete must be within 10% of the expected progress each grading period to be considered passing. Any percent progress that is greater than 10% below the expectation is a failing grade.*
  - *Please note that the “Grade to Date” in the MS World Language course is not the reported grade. This grade is determined by percent progress complete.*

Students are expected to make at least 3% progress per subject each week. *Exceptions to this requirement must be approved by administration.*

---

## STUDENT SUCCESS INITIATIVE

### The Student Success Initiative

#### State Law Requirements

The Student Success Initiative (SSI) was created by the Texas Legislature to ensure that all students receive the instruction and support they need to be academically successful in reading and mathematics.

Under the SSI grade advancement requirements, students are required to pass the State of Texas Assessments of Academic Readiness (STAAR) grade 5 reading and mathematics tests to be promoted to sixth grade. Additionally, students are required to pass the STAAR grade 8 reading and mathematics tests to be promoted to ninth grade.

In addition to the SSI grade advancement requirements, state law mandates that high school students must not only meet all their course requirements but also perform satisfactorily on up to 15 end-of-course assessments in English, mathematics, science, and social studies to receive a diploma from a Texas public high school.

#### What Happens at Grades 5 and 8?

Fifth and eighth grade students have three opportunities to pass the STAAR reading test and three opportunities to pass the STAAR mathematics test. If a student does not pass one or both tests, the school must give the student additional instruction after each testing opportunity, and the student must participate in that instruction. Parents will be notified if their child does not pass a STAAR test that is required for promotion.

If a student has not passed after the second testing opportunity, a grade placement committee (GPC) is formed. The GPC, which consists of the principal, teacher, and parent or guardian, will create an instructional plan based on the individual needs of the student.

#### Parents' Role in the Process

A student who is unsuccessful on the STAAR reading and/or mathematics test after the third testing opportunity will be retained automatically. However, the student's parents may appeal the decision to have their child repeat the grade by submitting a request to the GPC within five working days of receiving the retention notice. The GPC may decide to promote a student to the next grade, but only if everyone on the committee agrees that the student is likely to succeed in the next grade. Even if the GPC decides to promote the student, the student must participate in the required additional instruction in order to be promoted.

Parents may request a waiver of the third testing opportunity if they do not want their child to test. If the waiver is approved, the student is automatically retained, but the parents may still appeal the retention. A student must participate in all additional instruction required by the GPC, even if the third testing opportunity is waived.

NOTE: For information about how the Student Success Initiative applies to students receiving special education services, check with the special education contact on your campus.

## **STATE PHYSICAL EDUCATION REQUIREMENT**

PE is the only course that has a minimum time requirement. Texas Senate Bill 42 states that students in elementary and middle school/ junior high grades must have a minimum of 30 minutes of **documented physical activity** each day or a weekly total of 150 minutes. This daily activity needs to be tracked on the Fitness Log (found at the end of this POG). The time requirement is prorated for students enrolling after the first nine weeks. Students only need to complete 4 semesters of Physical Education in grades 6<sup>th</sup> through 8<sup>th</sup>.

---

## **COURSE PROMOTIONS**

### **Mid-Year Course Promotions**

We intend that our students complete 100 percent of the content in each course, should time permit. With this in mind, mid-year course promotions are not ordered until a student has achieved at least 90 percent mastery of a course with the understanding that a student will still complete 100 percent of that course. Mid-year course promotions are only allowed for math and English/language arts courses. New courses that are ordered mid-year must be worked on at the same 3% progress/week pace as expected for all other courses.

Students cannot begin a high school course after September 8, 2014, unless they enroll mid-year and show documentation that the first semester of a high school course has been completed/started.

### **End-of-Year Course Promotions**

TXVA encourages students to complete all lessons in a course since courses in the subsequent grade levels assume completion of lessons in the prior grade. A lesson is completed when the student has mastered the objectives as measured by the lesson assessment. It may not be necessary to teach every lesson if the student can demonstrate mastery of the objectives on the assessments.

The Online School<sup>®</sup> is designed to collect and record data that substantiates the academic progress of our students. Therefore, it is mandatory that the Online School<sup>®</sup> be used to enter attendance and assessment data that reflects the standing of the student. The Online School<sup>®</sup> data serves as the primary tool for determining advancement into subsequent course levels. It is essential that parents understand that by signing on with Texas Virtual Academy, they agree to participate in the program as designed including documenting regular and appropriate academic progress in the Online School<sup>®</sup>, participate in required conferences with the assigned teacher and participate in the state-mandated academic assessments.

TXVA requires that parents maintain samples of student work to assist teachers with the decision to advance a student to the next course/grade level. Examples of materials/work to keep on file include, but are not limited to, the following: handwriting samples, artwork, creative story samples, compositions, math work, and spelling tests.

At the Texas Virtual Academy we understand that our school is academically rigorous. Meeting the challenge of completing one year of course work in this model can be demanding. Our certified teachers are here to assist parents and students to meet the associated challenges. Parents and students should utilize their professional experience as students progress through our program. Please see further information about this topic in the “Grading Policy” section of this document.

---

## **FINISHING THE YEAR EARLY**

Students are required to work in the OLS every day through the last day of school, June 3, 2015. If a student needs to finish the school year prior to June 3<sup>rd</sup> then a written request must be made to the Principal for Grades 3-8, Kelly Morando, no later than May 1, 2015. The request may or may not be granted, depending on the circumstances.

---

## **WORK SAMPLES**

Students will be required to submit specific work samples on a monthly basis in each subject area. Work sample due dates will be communicated in kmail. Parents are provided a work sample submission guideline at the beginning of the school year and work sample submission is a topic of discussion during scheduled conferences. Part of a student’s grade is based on work sample submission.

TXVA requires student work to be original with appropriate citations for references to published works. Work samples must be turned in on time and submitted as requested through an online platform (surveys, k-mail, Blackboard Collaborate, Study Island, etc ). Parents should not "drop-off" work samples to teachers’ houses or at the TXVA office at any time.

---



## COURSE ORDER CHART

	3 <sup>rd</sup> Grade	4 <sup>th</sup> Grade	5 <sup>th</sup> Grade	6 <sup>th</sup> Grade	7 <sup>th</sup> Grade	8 <sup>th</sup> Grade
<b>English</b>	Literature 3 Lang Skills 3 Spelling 3	TX Literature 4 TX Lang Skills 4-GUM TX Lang Skills 4-COMP TX Lang Skills 4-Test Readiness TX Lang Skills 4-VOCAB TX Spelling 4	TX Literature 5 TX Lang Skills 5-GUM TX Lang Skills 5-COMP TX Lang Skills 5-Test Readiness TX Lang Skills 5-VOCAB TX Spelling 5	TX Intermediate Literature A TX Lang Skills A-GUM TX Lang Skills A-COMP TX Lang Skills A-VOCAB	TX Intermediate Literature B TX Lang Skills B-GUM TX Lang Skills B-COMP TX Lang Skills B-VOCAB	TX Literary Analysis and Comp-COMP TX Literary Analysis and Comp-GUM TX Literary Analysis and Comp-LIT TX Literary Analysis and Comp-VOCAB
<b>Math</b>	TX Math + Purple	TX Math + Red	TX Math + Yellow	TX Fundamentals of Geometry and Algebra	TX Pre-Algebra 7	TX Pre-Algebra 8 (same book as TX Pre-Algebra 8, different lesson order) TX MS Algebra I
<b>Social Studies</b>	Social Studies 3 (Texas)	Social Studies 4 (Texas)	Social Studies 5 (Texas)	Social Studies 6 (Texas)	Social Studies 7 (Texas)	American History A
<b>Science</b>	Science 3 (Texas)	Science 4 (Texas)	Science 5 (Texas)	Science 6 (Texas)	Science 7 (Texas)	Science 8 (Texas)
<b>Art (opt)</b> 6 <sup>th</sup> needs art or music	Art 3	Art 4	American Art A	American Art B	Inter Art: World A	Inter World Art: World B
<b>Music (opt)</b> 6 <sup>th</sup> needs art or music	Intro to Music	Intro to Music(new to K12) Intermediate 1 Music (Promoted from K12 3 <sup>rd</sup> to 4 <sup>th</sup> )	Exploring Music	Music Concepts A	Music Concepts B	
<b>World Language (opt)</b>				Spanish Middle School (Year 1 or 2) French Middle School (Year 1 or 2)		
<b>PE</b> 8 <sup>th</sup> opt if 4 semesters PE in MS already complete	Physical Education 3 (Texas)	Physical Education 4 (Texas)	Physical Education 5 (Texas)	TX Physical Education 6 (Texas)	TX Physical Education 7 (Texas)	TX Physical Education 8 (Texas)

<b>Study Island</b>	Study Island	Study Island	Study Island	Study Island	Study Island	Study Island
<b>Health</b>	Health & Fitness 3 (Texas)	Health & Fitness 4 (Texas)	Health & Fitness 5 (Texas)	Health & Fitness 6 (Texas)		TX Health 8 1 <sup>st</sup> semester

## **ASSESSMENT**

Throughout the year, students have the opportunity to demonstrate their acquisition of course academic objectives through the use of lesson assessments, unit assessments, online and offline benchmarking and STAAR testing. TXVA teachers may request student work samples to assist in assessing a student’s academic progress. Additionally, TXVA teachers will ask the students to participate in conferences to informally assess their understanding and comprehension. Students who do not complete required assessments may be referred to the Compliancy Committee.

Please note that lessons only count as completed progress when they are mastered, for which a score of 80% or better is required. If your student has lessons that are “complete but not mastered” (indicated by a half shaded green circle on the daily/weekly plan), those lessons are NOT counting toward a student’s progress yet and need to be mastered before they will. Lesson assessments can be retaken up to three times to achieve mastery. If a student does not master an assessment on the first attempt, the Learning Coach should review the assessment with the student, re-teach whatever portions remain challenging to the student, allow for additional practice, and then allow the student to re-test. Students should never retake an assessment immediately after failing; not mastering is an indication that more work in the lesson is needed. If a student fails an assessment three times, the teacher will need to be contacted to allow additional retesting opportunities.

If a student completes an excessive number of lessons in one day, teachers will ask for work samples. If the requested work samples are not submitted by the due date assigned, those lessons will be put back on the student’s plan for completion and the student may be placed on an Action Plan.

## **CLASS CONNECTS**

Teachers will hold Class Connect sessions each week in the subject areas of math, language arts, science, social studies, art, music, and PE per grade level. Some grade levels will also have Class Connect sessions for health, technology, and world languages. Some lessons may be taught with an interdisciplinary focus (i.e. using reading strategies for social studies material). All STAAR tested subjects will have required Class Connects. These required sessions will be stated on the ILP. Students in grades 6-8 will have the opportunity to earn Class Connect credit for most sessions through topic mastery in Study Island. More information about this will be sent out in kmail closer to the start of Class Connects, September 15th. Students are encouraged to attend Class Connects for subjects that are not STAAR tested, but attendance is not required unless stated on their ILP or in kmail.

Required Class Connect sessions are worth 20% of the overall grade for grades 3-8. If a student is not required to attend sessions as written in their ILP, then that student will be graded on the not required to Attend Class Connects grading scale (See “Grading Policy and Report Cards” area above). For those students who are required to attend Class Connect sessions as stated in their ILP, they will be given a grade of 100 percent for attendance at each session or a zero percent for each missed session. Parents will receive the Class Connect schedule for their grade level and it will also be posted in the weekly homeroom newsletter.

REQUIRED Class Connect Sessions:

- ALL 3rd graders are required to attend the weekly Math and Reading CC sessions.
- ALL 4th graders are required to attend the weekly Math, Reading, and ELA/Writing CC sessions.
- ALL 5th graders are required to attend the weekly Math, Reading, and Science CC sessions.
- ALL 6th graders are required to attend the weekly Math and Reading CC sessions.
- ALL 7th graders are required to attend the weekly Math, Reading, and ELA/Writing CC sessions.
- ALL 8th graders are required to attend the weekly Math, Reading, Science, and Social Studies CC sessions.

---

## **SUPPLEMENTAL ACTIVITIES**

Parents seek to provide the best possible education for their child and often enrich the child’s curriculum with extra activities and family trips. These activities may be logged in the student’s daily schedule and counted toward his/her mandatory hours of instruction *if the activity directly relates to lesson objectives*. However, it is important that parents discuss their supplemental activities with their student’s assigned TXVA teacher before logging the attendance time to ensure that the supplemental activities are permissible and recorded in the appropriate area(s) of the curriculum.

---

## **STRONG START WEB SITE**

<http://txva.k12start.com> is an important resource for our families. It includes an outing and testing calendar, videos to help orient you to the school, a link to K12’s Parent Network, and much more. Be sure to bookmark it and check back often!

---

## **PARENT/STUDENT/TEACHER COMMUNICATION**

Certified Texas teachers are an essential component of the educational model utilized by the Texas Virtual Academy. The teacher is responsible for validating student attendance, curricular progress and educational growth. **The teacher is also the first point of contact**

**for the parents and students with all issues regarding the school.** Resources provided by TXVA teachers include: instructional and curricular support, organizational assistance, Blackboard Collaborate instruction and tutoring, and ‘good old-fashioned’ encouragement. A healthy working relationship between the student/parent and the assigned TXVA teacher is essential. Parents and students are required to participate in conferences and class meetings with their TXVA teacher. It is essential for teachers to be able to speak with students. **If a student is not available for a conference, the teacher will reschedule the meeting.**

K-mail is a primary source of contact between the TXVA teacher and the parents/students; therefore, parents and students are encouraged to check their K-mail at least twice a day (morning and evening). Parents and students are asked to promptly reply to any K-mail received. TXVA teachers are instructed to allow their voice mail to answer all in-coming calls. This allows teachers to thoroughly research the answer to questions or problems posed by parents and to prioritize returning calls to make the most efficient and effective use of their time. This also allows long-distance calls to be charged to TXVA and not to the parent. TXVA does not reimburse parents for long-distance calls. Parents and students are expected to inform their TXVA teacher of any changes to contact information. Parents must also update contact information (phone and email address) within the “my info” area of the Online School.<sup>®</sup> Addresses must be changed through the school office (see “Address Change” area of this document for more information).

The Online School<sup>®</sup> includes a landing page for each parent and student account. The landing page provides families easier access to all aspects of the Online School<sup>®</sup>. TXVA posts important, school-wide information in the Announcements section of the landing page.

---

## **CONFERENCES**

One of the strongest points of the school’s program is the close monitoring of each student’s educational progress. Parents *and* students are required to participate in scheduled conferences with their TXVA teacher. Each student will have a conference during quarters 1, 2, and 4 (depending on enrollment date) and some students may have one during quarter 3. The conference is an opportunity to voice concerns, relay good news about the student, obtain enrichment ideas for the child, and discuss attendance and progress through the curriculum, which are vital to success in the program. The teacher and learning coach will also work together to set goals for the student on the Individual Learning Plan (ILP). The students are expected to participate in all conferences. Since regular attendance at these conferences is mandatory to stay enrolled in TXVA, it is expected that students and parents attend all of their scheduled conferences, provide 24 hours notice if a cancellation is required for the conference, and reschedule when it is cancelled. Learning coaches and students who miss a scheduled conference and do not hold a make up conference within two weeks will be placed on an Action Plan.

---

## **STUDENT GOALS & INDIVIDUAL LEARNING PLANS (ILPs)**

In order to better satisfy each student’s individual learning needs, TXVA teachers collaborate with parents and students to establish individual student curriculum goals. These goals are designed to both clarify and guide the student’s learning experience while motivating the

student and increasing the likelihood of high academic achievement. Progress goals will be based on a student's enrollment date, and these goals will be written to ensure a student meets or exceeds standards.

Teachers, students, and learning coaches may modify the ILP goals as the school year progresses. Dedicated TXVA teachers work closely with students and learning coaches to formulate realistic expectations as well as provide feedback toward the goals set forth in the plans during scheduled parent/teacher conferences.

Students may have additional goals written into their Individualized Learning Plans (ILPs) based on the teacher's discretion. Such goals may include attendance, testing, participation in Study Island, participation/attendance at test preparatory sessions, participation/attendance at tutoring sessions, etc. Remember that failure to attend required sessions is a matter of non-compliance and will result in an Action Plan being started and truancy charges possibly being filed.

---

## **CLASS MEETINGS**

All students in grades 3-8 will be expected to participate in Monday Morning Meetings with their teachers. Each meeting will last no more than one hour. Teachers will present important information for both the students and parents; however, parental attendance is optional. These meetings are also a time for school announcements, reminders, homeroom celebrations and fun student activities. The goal of these meetings is to reinforce the relationship between the student and the teachers and also for students to have more time with their peers. These meetings will be recorded, so if a student is unable to attend live, the parent and student are responsible for listening to the recording within 24 hours and following up with their teacher if they have any questions.

---

## **ADMINISTRATION TOWN HALL MEETINGS**

TXVA Administrators may hold Town Hall Meetings throughout the school year. Please take this opportunity to meet the TXVA Administrative team and share in a round table discussion. Town Hall Meeting times and dates will be provided by your teachers and administrators.

---

## **CHILD FIND**

Child Find is a process based on the Individuals with Disabilities Act (IDEA) Part C. The purpose is to identify, locate and evaluate individuals with disabilities who may need special education services. Anyone can initiate the process: a parent, doctor, teacher, relative or friend.

To ensure that all TXVA students are properly identified and served, the parent or guardian will be asked if their student has ever been evaluated for possible special education services, and if the student has ever received special education services as a student in a public or

private school. If so, the parent or guardian will be asked if their student have an active Individual Education Plan (IEP).

Additionally, if parents believe their student may have a disability, they can refer their students for academic assistance and consideration for Special Education services. This can be accomplished by contacting the student's homeroom teacher.

---

## **SPECIAL EDUCATION SERVICES**

TXVA is responsible for providing a free and appropriate education under the federal Individuals with Disabilities in Education Act (IDEA). Special Education professionals assist parents in accessing and coordinating services pursuant to a current Individualized Education Plan. Parents should indicate that their child has an Individualized Education Plan on their enrollment form.

Special education services are available to students who have been identified with a disability. Documentation of the disability must be provided; such as a previous Individualized Education Plan (IEP) and/or a psychological evaluation. Students with IEPs in need of adapted learning support services are those whose complex learning needs impact their academic achievement and their ability to make sufficient progress toward IEP goals in the general education setting. Services offered may include: adaptations and modifications to the general education curriculum, specialized instructional strategies, and adjustments in pacing. The TXVA program is considered an **inclusion** program. The student's home is the regular classroom and services are provided by consultation with a highly-qualified special education teacher via phone, k-mail and the online (virtual) classroom.

### **What to expect:**

- Every special education student will be assigned a special education teacher in addition to their regular education teacher.
- The special education teacher will work with the learning coach on IEP goals, how to modify and adapt the learning environment, and curriculum paths for success.
- The special education teacher, the regular education teacher, and the learning coach will meet together for a conference via Blackboard once every quarter.
- The special education teacher may hold Class Connects online to assist students with their specific learning needs depending on their IEP goals.
- The special education teacher is available to be used as a resource for instructional strategies and adaptations and modifications to the curriculum.
- ARD meetings will be held either online or through the use of a conference call line.
- Special Education students are required to meet the same attendance policies as their peers. The home environment, one on one instruction, and flexible schedule can help the students create a learning environment that meet their specific needs.

The Texas Virtual Academy's Special Education department is managed by Responsive Education Solutions (our host district), and led by Tammy Rogeness, Director of Virtual School Special Education.

Communication between General Education and Special Education Staff is extremely important. Any questions regarding Special Education services for a specific student should be directed to that student's Special Education Teacher. General questions about Special Education programs can be directed to any of the following:

Tammy Rogeness, Director of Virtual School Special Education,  
[tmeyn-rogeness@responsiveed.com](mailto:tmeyn-rogeness@responsiveed.com)

---

## **RELATED SERVICES**

Related services, placement and goals are determined by the ARD Committee. Options for related services should be discussed with the special education staff before a decision is made to enroll with TXVA.

TXVA provides related services through contracts with service providers (speech pathologists, occupational therapists, etc). It is important for students and parents to attend all related services appointments in order for the student to receive maximum benefit and achieve IEP goals.

We understand that it is our responsibility to provide a free and appropriate public education to each enrolled special education student. Because TXVA is a virtual school of choice, it is understood that speech and related services are provided face to face; however, not in the home environment. Services will be offered at the nearest office to the family's home or virtually with a licensed provider.

If you have questions regarding related services, please contact the RES Special Education office or reach out to Tammy Rogeness at [tmeyn-rogeness@responsiveed.com](mailto:tmeyn-rogeness@responsiveed.com).

---

## **504 SERVICES**

Section 504 is a federal law designed to protect the rights of individuals with disabilities in programs and activities that receive Federal financial assistance from the U.S. Department of Education (such as a public school like TXVA). Under this law, ***individuals with disabilities*** are defined as persons with a physical or mental impairment which substantially limits one or more major life activities. Individuals who have a history of, or who are regarded as having a physical or mental impairment that substantially limits one or more major life activities, are also covered. Major life activities include caring for one's self, walking, seeing, hearing, speaking, breathing, working, performing manual tasks, and learning. Some examples of impairments which may substantially limit major life activities, even with the help of medication or aids/devices, are: AIDS, alcoholism, blindness or visual impairment, cancer, deafness or hearing impairment, diabetes, drug addiction, heart disease, and mental illness.

"No otherwise qualified individual with handicaps in the United States... shall, solely by reason of his or her handicap, be excluded from the participation in, be denied the benefits of, or be subjected to discrimination under any program or activity receiving Federal financial assistance..." 9 U.S.C. 794(a)

What does this mean? This means if your student has a physical or mental impairment, they may qualify for services under Section 504. This allows the District to provide accommodations to help your student better access the curriculum if their physical or mental impairment is preventing them from being successful.

To determine if your student is eligible for Section 504 services, we will need to conduct an evaluation which includes gathering information from teachers, medical professionals, and you as the parent. If you would like to further investigate your student's eligibility for accommodations provided under the umbrella of Section 504, please reach out to:

Ashley Deets  
504 Coordinator  
972-696-9190

---

## **RESPONSE TO INTERVENTION (RTI)**

Response to Intervention (RtI) Services at TXVA are available for students who have been identified as academically "at-risk". A student that is defined as "at-risk" has tested significantly below on his/her assessments, has demonstrated that he/she is struggling with the current curriculum he/she is enrolled in, or has been identified with some type of need on the Child Find screening.

RtI is based on the concept of providing evidence-based instructional and behavioral strategies by highly qualified personnel that are matched to the student's needs, and those needs are monitored on a frequent scheduled basis.

### **The goals of RtI at TXVA:**

- Create a productive learning experience for all TXVA students
- Support students in reaching grade level performance
- Use prevention rather than reaction to student difficulties
- Exhaust all general education options before making a special education referral.

### **How to request RtI assistance and what to expect:**

**1st:** Students can be placed into the RTI program through a referral of a teacher, administrator, or learning coach. The learning coach can make a request through the teacher for RTI support.

**2nd:** The teacher will make a tier 1 plan based on the student needs. This will include gathering data from whole group and small group interventions and the effectiveness of those interventions. Monitoring of the RTI plan should take place every two weeks.

**3rd:** If after the first 30 days the tier 1 plan shows not to be effective, a tier 2 referral can be requested by the teacher. A Response to Intervention team member will set up an initial tier 2



meeting with the learning coach and the regular education teacher to review the needs of the student and develop a tier 2 plan for interventions.

**4th:** The Response to Intervention team will review the case after the student has had ample time to work through the coursework with appropriate interventions to determine whether the student will need ongoing interventions or a referral for a tier 3 intervention plan.

The process for Rtl requires the student to move through three tiers of intervention (for a minimum of 30 days in each tier). The process includes monitoring meetings and RTI sessions that are mandatory for the student and/or Learning Coach. Our goal is to support the student's needs without placing a learning disability label on them. *The entire process of intervention before a possible referral will take a minimum of 90-120 days depending on the outcome of each tiered plan.*

You may contact Teri Heims, Rtl Coordinator, at [theims@k12.com](mailto:theims@k12.com) if you have further questions.

---

## **ADVANCED LEARNERS**

Many TXVA students have participated in Gifted and Talented or Advanced Learner programs before enrolling in our program. The OLS curriculum is already very complex and all students may work above level in their math and language arts courses if they complete the current grade level work. (Students cannot begin a high school course after September 8, 2014, unless they transfer in mid-year and have proof of enrollment in high school credit course at prior school and successful completion of that course to date.) Additionally, TXVA and K12 offer some ALP activities and events for students. If you feel that your student needs enrichment or more challenging work, please speak with your TXVA teacher and he/she will assist you with finding a way to meet the needs of your child. You may also contact Patrick Lambert, Special Programs Coordinator, at [tlambert@k12.com](mailto:tlambert@k12.com) for more information.

---

## **Dyslexia Program**

Children learn to read in different ways. When conventional instruction is not working, we must intervene on behalf of that child's future education. Students who show signs of dyslexia may need intervention to be successful in school. The TXVA Dyslexia Intervention Program is offered for those students who meet program specifications according to the State of Texas. [CLICK HERE](#) to view an online copy of the Texas Dyslexia Handbook (revised 2007, updated 2010).

### **Response to Intervention (Rtl):**

Students showing academic difficulties are referred to the Rtl program. A child can be referred to the Rtl program by a parent, teacher, or administrator for State Testing difficulties. Preventative measures and remedial strategies are a part of the intervention process. After

working with a teacher(s) in the Rtl program, students still showing academic difficulties can be referred for a dyslexia screening.

### **Referral to Dyslexia Program:**

Students should be referred to the Dyslexia Program after being identified through Rtl as showing characteristics associated with dyslexia.

From *The Dyslexia Handbook (2007, 2010)*; Common Evidence of Dyslexia can include:

- [Student who] Fails to understand that words come apart; for example, that snowman can be pulled apart into snow and man and, later on, that the word man can be broken down still further and sounded out as /m/ /ă/ /n/
- Has difficulty learning the letter names and their corresponding sounds
- Has difficulty decoding single words (reading single words in isolation)—lacks a strategy
- Has difficulty spelling phonetically
- Reads dysfluently (choppy and labored)
- Relies on context to recognize a word
- Has a history of reading and spelling difficulties
- Avoids reading aloud
- Reads most materials slowly; oral reading is labored, not fluent
- Avoids reading for pleasure
- May have an inadequate vocabulary
- Has difficulty spelling; may resort to using less complicated words in writing that are easier to spell (*The Dyslexia Handbook*, pp 11-12)

The referral should consider that the Texas Education Code (TEC) §38.003 defines dyslexia in the following way:

*(1) Dyslexia means a disorder of constitutional origin manifested by a difficulty in learning to read, write, or spell, despite conventional instruction, adequate intelligence, and sociocultural opportunity.*

*(2) Related disorders includes disorders similar to or related to dyslexia such as developmental auditory imperception, dysphasia, specific developmental dyslexia, developmental dysgraphia, and developmental spelling disability.*

<http://www.statutes.legis.state.tx.us/Docs/ED/htm/ED.38.htm#38.003>

### **Evaluation**

Students can receive services for Dyslexia remediation under the umbrella of Section 504. If a student is referred for a Dyslexia Evaluation, the District must gain signed permission to evaluate from the student's legal guardian. This permission allows the student to be assessed in the suspected deficit areas and allows those assessment results to be used to determine eligibility for an accommodation plan provided through Section 504.

Trained personnel administer the Dyslexia assessment face to face with the student. This assessment typically takes place close to the student's residence and arrangements are made with the student's parents and the assessor.

When the evaluation is completed, a Section 504 meeting will be scheduled in a timely manner with the parent/guardian and school staff to discuss the assessment results and determine eligibility. The 504 committee will discuss a plan of action based on the assessment results and the documented needs of the student. This may include a 504 Accommodation Plan with Dyslexia services.

### **Dyslexia Program**

TXVA's Dyslexia program is much like the pullout classes that are offered for students in a traditional school setting. We offer class connects and an online reading program based in phonics instruction. Dyslexia classes are offered throughout the grade levels (3-12). The dyslexia teacher coordinates office hours and optional classes to help students in other courses as well.

---

## **FAMILY EDUCATION RIGHTS AND PRIVACY ACT (FERPA)**

The Family Educational Rights and Privacy Act (FERPA) provides parents and students over 18 years of age ("eligible students") certain rights regarding the student's education records. These rights are:

(1) The right to inspect and review the student's education records within 45 days of the day the School receives a request for access.

To request an inspection and review, the parent or eligible student should submit a written request to the Head of School that identifies the record (s) they wish to inspect. The Head of School makes arrangements for access and notifies the parent or eligible student of the time and place where the records may be inspected.

(2) The right to request an amendment of the student's education records that the parent or eligible student believes are inaccurate.

Parents or eligible students may ask the School to amend a record that they believe is inaccurate. They should write the Head of School, clearly identify the part of the record they want changed, and specify why it is inaccurate. If the School decides not to amend the record as requested by the parent or eligible student, the School notifies the parent or eligible student of the decision and advises him/her of his/her right to a hearing regarding the request for amendment. Additional information regarding the hearing procedures is provided to the parent or eligible student when notified of the right to a hearing.

(3) The right to consent to disclosures of personally identifiable information contained in the student's education records, except to the extent that FERPA allows disclosure without consent.

One exception that permits the School to disclose information without consent is when the School discloses information to school officials with legitimate educational interests. A school official is a person employed by or contracted to provide services to or designated by the contractor to provide services to the School as an administrator, supervisor, instructor, or support staff member (including health or medical staff and law enforcement unit personnel); a person serving on the Board of Directors of the School; a person or company with whom the School has contracted to perform a special task (such as an attorney, auditor, medical consultant, or therapist); or a parent or student serving on an official committee, such as a disciplinary or grievance committee, or assisting another school official in performing his or her tasks.

A school official has a legitimate educational interest if the official needs to review an education record in order to fulfill his or her professional responsibility.

Upon request, the School discloses education records without consent to officials of another school district in which a student seeks or intends to enroll.

- (4) The right to file a complaint with the U.S. Department of Education concerning alleged failures by the School to comply with the requirements of FERPA. The name and address of the Office that administers FERPA are:

Family Policy Compliance Office  
U.S. Department of Education  
400 Maryland Ave., S.W.  
Washington, D.C. 20202-4605

(5) FERPA requires that the School, with certain exceptions, obtain a parent's or eligible student's written consent prior to the disclosure of personally identifiable information from a child's education records. However, the School may disclose "directory information" without written consent, the parent or eligible student, have advised the School in writing that he/she does not want all or part of the directory information disclosed. The method for objecting to disclosure of directory information is specified below. The primary purpose of directory information is to allow the School to include the following information from education records in certain school publications or disclose it to certain parties. Examples include:

- Shipment of computer and school materials to and from student's home
- Entry of student enrollment information into a computer database for use by school officials
- Sports activity sheets, such as for wrestling, showing weight and height of team members

Directory information, which is information that is generally not considered harmful or an invasion of privacy if released, can be disclosed to outside organizations without a parent's prior written consent. In addition, federal laws requires the School to provide military recruiters, upon request, with three directory information categories – names, addresses and telephone listings – unless parents or eligible students have advised the School in writing that they do not want their student's information disclosed without prior written consent.

The School has designated the following information as directory information:

- name

- address
- telephone number
- e-mail address
- photo
- athletic information
- grade level
- activities and clubs
- awards

If there are certain items the School has chosen to designate as directory information that parents do not want disclosed from their student's education records, without their prior written consent, parents are encouraged to send an e-mail identifying the information they do not want disclosed, the student's name, and the name of the virtual academy or affiliate school in which the student is enrolled to: [directoryinformation@k12.com](mailto:directoryinformation@k12.com). This e-mail must be sent within 30 days of the first day the student attends school.

Notice of these rights is available, upon request, on audiotape, in Braille, and in languages other than English.

---

## **SCHOOL PROPERTY**

TXVA provides materials, computer (if applicable), printer, books and other curricular supplies. These materials are school property and must be kept in good condition. Parents are responsible for the repair or replacement of all lost, stolen or damaged school property. A list of property that must be returned is provided to parents. All property and equipment must be returned in good, working condition upon withdrawal from the program or completion of the school year. If a piece of TXVA electronic equipment isn't working properly, the parent should contact K12 Customer Care at 1-866-512-2273 and troubleshoot with the technical support team. Parents should not repair any of TXVA/K12's equipment. All printed materials are copyrighted and unauthorized copying of that material is a copyright infringement. Materials cannot be sold or transferred and are to be used solely by the student in his/her studies while enrolled in the school. Parents are to comply with this policy and all the terms and conditions of the Use of Instructional Property Agreement submitted with the enrollment materials.

---

## **OBJECTIONABLE MATERIALS POLICY**

There may be times a parent finds certain lessons, books or materials objectionable for various reasons. If a parent finds objectionable material, he/she should contact his/her TXVA teacher via k-mail. Teachers work with parents to find alternative lessons to meet the lesson objectives. The assessment for the lesson must be completed to show that the objectives have been met. Parents should also contact K12<sup>®</sup> directly using the feedback option of the OLS<sup>®</sup>.

## **REMOVAL FROM TXVA**

Students may be removed from the TXVA due to disciplinary action, lack of attendance/progress, failure to participate in state-mandated assessments, or attendance in another school. Students are provided all necessary due process rights before removal. TXVA administrators and teachers may recommend expulsion to the Expulsion Hearing Committee for student violation of school policies. Students and parents are made aware of the date and time for an expulsion hearing before the Expulsion Hearing Committee. Public schools in the state may refuse admission to a student who has been expelled from TXVA.

---

## **ADMISSION OF HOMELESS CHILDREN AND YOUTH**

The McKinney Act of 1987, or P.L. 100-77, ensures that each child of a homeless individual and each homeless youth shall have equal access to the same free, appropriate public education as provided to other children and youth. Under the Act, schools are prohibited from delaying a homeless child's entry into school due to delays in obtaining school records. Rules regarding guardianship must be waived for homeless students living with foster parents or relatives other than their legal guardians.

Parents may review the Texas Virtual Academy's Admission of Homeless Children and Youth policy by calling the school office at 972-420-1404.

---

## **PARENT ACCESS TO STAFF CERTIFICATIONS**

Parents may review certifications of Texas Virtual Academy teachers by request. Please direct your request to Kelly Morando, Principal.

---

## **COMPLAINT RESPONSE PROCEDURE**

The Texas Virtual Academy is interested in achieving and fostering student/family satisfaction. The following procedure ensures that student/family grievances are addressed fairly by the appropriate people in a timely manner. TXVA prohibits discrimination against students/families on the basis of disability, race, creed, color, gender, national origin, or religion.

The student and parent(s), custodian(s) or legal guardian(s), address in writing any concern or grievance to the Head of School. The Head of School responds within ten (10) working days.

If the concern or grievance is not resolved by the Head of School, the parent(s), custodian(s) or legal guardian(s) may, within ten (10) working days of the Head of School's response,

request in writing a meeting (via phone or in person) with the Head of School to discuss the concern or grievance. He/she investigates and responds within ten (10) working days.

If the family's concern is not resolved at the meeting with the Head of School, the family may file a complaint with the RES governing body. The RES governing body may address the complaint directly.

---

## **FAMILY DIRECTORY**

The TXVA Family Directory is accessed through the OLS. Parents are able to find other parents by location of their homes and student grade levels. Parents may search by name and other information in a parent profile. The new directory is automatically updated as a parent's status changes, such as moving across town or changing an e-mail address. There is an online opt-in/out capability on the OLS so parents can easily include or exclude themselves from the directory.

Families should keep their email and phone number information updated in the "my info" area of the OLS. Addresses need to be changed through the TXVA school office. See information under "Address Changes" above.

---

## **PARENT CONNECTIONS**

Parents are encouraged to become involved in their school community through participation in outings and clubs and also arranging other "non-official" outings with TXVA parents. Parents may freely meet and organize unofficial outings as they wish. These outings are not considered "official" outings unless a TXVA representative attends.

A weekly newsletter ("The Trailblazer") is distributed each Monday. It is paramount that parents take the time to review these. The newsletters contain important information about upcoming events, special announcements and other helpful school information.

There is also a K12 Parent Network, which is accessible from <http://txva.k12start.com>.

---

## **SCHOOL OUTINGS & STUDENT ACTIVITY CLUBS**

TXVA sponsors optional outings for students and families on a regular basis that enhance the K12 curriculum/learning activities. While attendance is not mandatory, it is a wonderful opportunity to meet other school participants and share information about programs and successful practices. Outings are opportunities for both the students and parents to socialize. It is our hope that the teachers and parents will work together to plan and implement these activities. Parents are responsible for the cost of transportation and any entrance fees

associated with optional outings. Credit for field trips is not offered in lieu of the regular OLS requirements.

TXVA expects students and adults to dress appropriately when attending outings. Examples, of inappropriate dress include:

- Clothing, apparel, or jewelry that by words, signs, pictures, or any other combinations thereof, advocates or promotes sexual activity, violence, death, suicide, or the use of alcohol or drugs, or demeans, degrades, or intimidates another because of race, sex, religious persuasions, national origin, disability, or gang membership.
- Apparel that reveals or exposes the midriff/lower back or sides of the upper body or torso and/or undergarments.
- Any clothing that is excessively tight, is of transparent material, see through material, or that is ripped or torn, or has suggestive signs or symbols.
- Any clothing through which underwear or any type of undergarment may be seen.
- Spandex, clothing that does not cover backs, clothing that permits viewing of cleavage, halter tops, tank tops with open sides, spaghetti strap tops, and muscle/tank shirts.
- Spikes, dog chains/chokers, ball bearing chains, wallet chains, or other jewelry that increases the risk for accidents.

TXVA parents, learning coaches and students are expected to conduct themselves appropriately at all optional outings. Parents/Learning Coaches are responsible for supervision of their children at all times.

Please refer to your homeroom teacher and/or the online calendar for a list of outings being held across the state.

<http://txva.k12start.com>

Learning coaches will need to provide their signature on a sign in sheet that the teacher will provide at each outing releasing TXVA of any liability associated with the outing. (found at the end of this document for you to review).

Many of our outings are great opportunities for photos. At the end of this document you will also find a photo release that the teacher will also bring to each outing that we will need your signature on for us to use any pictures of your children. If you are NOT comfortable having your child's picture taken or shared, please let the teacher at the outing know, and we'll be sure he/she is not in any of the pictures that we share.

K12 offers a large selection of national virtual clubs for all grade levels. You can ask your homeroom teacher for more information about these great opportunities!

---

## **NATIONAL MATH LAB**

K12 and TXVA partner to offer a National Math Lab to our students in grades 5 and up who struggle with mathematics. This is live, supplemental online math remediation offered four times per week by one of K12's National Math Lab teachers. These sessions are entirely



voluntary and are in addition to the math course work and Class Connects that the student may be required to attend as a student at TXVA. There are five modules of National Math Lab: number sense, fractions, measurement, algebra and geometry. Each module has two levels and lasts nine weeks. If you are interested in learning more, please view this video and/or contact Mr. Lambert (info below).

[Introduction to K12's National Math Lab](#)

Patrick Lambert, Special Programs Manager [tlambert@k12.com](mailto:tlambert@k12.com)

---

## **TECHNOLOGY ISSUES AND USAGE**

All issues regarding K12<sup>®</sup> computers can be directed to K12<sup>®</sup> technical support directly. Technical support is available at 866-626-6413 daily between the hours of 7 am and 7 pm Central Time. Access to the Internet via equipment and resource networks provided to families as a result of their enrollment in TXVA are intended to serve and pursue educational goals and purposes. In addition, parents are to comply with the Use of Instructional Property Agreement completed as part of the enrollment process.

Communications and Internet access should be conducted in a responsible and professional manner reflecting the school's commitment to honest, ethical and non-discriminatory practice. Therefore the following is prohibited:

- Any use that violates federal, state, or local law or regulation.
  - Knowing or reckless interference with the normal operation of computers, peripherals, or networks.
  - The use of TXVA Internet-related systems to access, transmit, store, display, or request inappropriate materials.
  - Any use that is deemed to adversely affect TXVA.  
Violation of TXVA or K12<sup>®</sup>'s Terms of Use for any TXVA or K12<sup>®</sup> website.
- 

## **INTERNET SERVICE PROVIDER (ISP) SUPPLEMENT POLICY**

ISP checks are issued automatically to those families who qualify twice per year; after the end of each semester. Typically this is in the February/March timeframe for the 1<sup>st</sup> semester and the Aug/Sept timeframe for the 2<sup>nd</sup> semester. In order to be eligible for the ISP supplement, each TXVA student in the family must meet all of the following criteria:

- Meet income eligibility requirements
- Participate in the Online School for sixty (60) calendar days
- Be enrolled on the last day of the semester
- Participate in all required standardized testing including Scantron and Study Island benchmarking, and all State required testing including STAAR assessments

- Successfully complete assigned coursework (pass all courses with either an “P” or a “C” or better)
- Have an average of at least 6 hours of attendance per day

Families enrolled prior to the 15th of each month will be eligible for the supplement for that month’s ISP. Families enrolling after the 15th of the month will qualify for the supplement beginning the 1st day of the next month.

The amount of the supplement for those families who qualify is \$12.00 per eligible month per family.

### **Families with Two or More Students**

Families with two or more students will receive the supplement at the rate of \$12 per eligible month.

### **Lost Checks**

Please be aware that if an ISP check is lost, TXVA does not automatically reissue a check to that family. If a check is lost, parents need to notify the Finance Coordinator within 90 days for a replacement to be issued.

Sherrill Johnston  
Finance Coordinator  
972.420.1404 ext 2016

---

## **NETWORK ETIQUETTE**

As a TEXAS VIRTUAL ACADEMY student, you are expected to follow the rules of network etiquette or “netiquette.” The word “netiquette” refers to common-sense guidelines for conversing with others online. Please abide by these standards:

- Avoid sarcasm, jargon, and slang. Swear words are unacceptable.
- Never use derogatory comments, including those regarding race, age, gender, sexual orientation, religion, ability, political persuasion, body type, physical or mental health, or access issues. being discussed, not on the individuals involved.
- Focus your responses on the questions or issues
- Be constructive with your criticism, not hurtful.
- Review your messages before sending them. Remove easily misinterpreted language and proofread for typos.
- Respect other people’s privacy. Don’t broadcast online discussions, and never reveal other people’s email addresses or other personally identifiable information.

---

## **CYBER BULLYING**

**What is cyber bullying?**

Cyber bullying is sending any type of threatening or hateful message to someone over the Internet or a cell phone. Many people believe that they can get away with this type of behavior. They mistakenly think they can hide their identity and won't have to take responsibility for their actions.

### **How can cyber bullying be prevented?**

Talk about it before it ever happens. Many young people are not aware that saying hurtful things about another person, calling him/her names in an email, or telling lies about someone, even as a joke, is a form of cyber bullying.

### **What do you do if you are a victim of cyber bullying?**

- Ignore the person and the comments. Most bullies want the attention they gain and will give up if they are ignored. If you respond to their messages, they will know that you are affected, which will encourage them to continue.
  - Leave the site or get off the Internet immediately. Most email services and instant message sites also allow you to block access to another person.
  - Change your screen name or email address. Be sure to only give the new one to your friends.
  - Tell your parents.
  - Make a copy of any threatening or outrageous email messages in case you need proof later.
- Report the bullying behavior to the proper authorities – the site moderator, the school, or even the police.

---

## **INTERNET SAFETY TIPS**

We ask you to take some time to talk with your child about internet safety and set boundaries/rules that you feel are appropriate for your family. Here are a few of our recommendations.

1. Keep your computer in an open room with the front of the monitor visible. That way, you can easily see what sites your children are viewing. The K12 lessons sometimes have links to other sites, but before you leave their website, there is always a pop-up that verifies that you want to leave. While the internet is a fabulous tool, we all know that it can present dangers to our children.
2. Establish rules for going online, including what time of day, the amount of time, and what sites they can access.
3. Bookmark child friendly sites for your student to visit.
4. Teach your students never to open email or attachments from anyone they don't know.

5. Remind students that people they meet online may not be who they say they are.
6. Never allow your student to meet face to face with another person they meet online unless they have your permission and you accompany them to the meeting.
7. Teach your student to immediately turn off the computer and tell you if they have any experience that makes them feel uncomfortable.
8. Remind your children not to share any personal information, including full name, address, email address, social media ids, phone numbers, passwords, etc., on the Internet.

TXVA Specific Internet Rules:

- 
1. At no time should a web site or a link be posted during a TXVA Monday Morning Meeting, Study Hall, Class Connect session or any other Blackboard Collaborate session. Disciplinary action can follow if this occurs.
  2. If any student invites other students to private Blackboard or online rooms during a TXVA online session of any kind, the parent of those students will be notified and disciplinary action can follow.
  3. During any TXVA online session name calling, using swear words or making derogatory comments are unacceptable and disciplinary action can follow if it occurs.
  4. At no time should a student post or share personal information during a TXVA Monday Morning Meeting, Study Hall, Class Connect or any other type of Blackboard Collaborate session. This includes first and last name, email address, home address, social media data, photographs, and/or phone number.
- 

## **INFORMATIONAL WEBSITES**

The following websites may prove helpful when computer questions or technical difficulties arise.

<http://www.google.com> – Widely used search engine

<http://www.whatis.com> – provides definitions of most technical terms, concepts and ideas

<http://www.howstuffworks.com> – provides information on how computer hardware and software work in addition to about everything else one could ever want information about

<http://housecall.antivirus.com> – free online virus scanner that can be used as a “second opinion” to the installed antivirus software

<http://www.homenethelp.com> – provides information for setting up and troubleshooting a home network environment

<http://www.computerhope.com> – free computer help for everyone. Drivers, questions & answers, and forums.

<http://support.microsoft.com> – Microsoft’s self-help support web site including data base of common issues and resolutions

<http://www.webopedia.com> – online dictionary and search engine for computer and internet terms

<http://www.modemhelp.net> – more advanced site that provides information on error messages and screenshots for troubleshooting technical issues

<http://www.dslreports.com> – information on DSL, Cable, and other high speed internet connections

<http://help.k12.com> – K<sup>12</sup>™ website that provides troubleshooting information for common issues experienced by families and download points for technical tools

---

## **FAQ's**

### ***What if I am having trouble with my login?***

K<sup>12</sup> customer service is the best ones to call to help you with that. 1-866-512-2273

### ***Do I need to have a student account set up for my child?***

Students in EVERY grade are required to have their own student login. The reason for students needing their own OLS login is so that when they sign into their Class Connect sessions, their name appears in the online classroom and not the learning coach's name. The student log in will not have answer keys or teacher guides. Each student should have their own account that they actively use each day.

### ***How do I create a Learning Coach or student account?***

<https://fw.unitymg.com/rdr/C:7433>

### ***What should I do when I have a question?***

Contact your teacher via k-mail or by phone. It may be easier to k-mail your teacher so that s/he can read over what the issue is and take the time to help find the answer if needed. Office hours are from 8am to 5pm Monday through Friday.

### ***There is so much to do. Do I really need to read everything my teacher sends me?***

YES, YES, and YES!!!! Your teacher will send out pertinent information and it is very important that you open and read each k-mail. K-mails are the teacher's primary communication tool with his/her classroom.

### ***Can we write in the student guides or will we have to return those materials?***

Yes, you may write in the student guides, teacher guides, and most other workbook type books. Please do not write in textbooks or story books. You can find out what materials need to be returned by consulting your "My Info" area of the OLS or contacting K12 Customer Care at 1-866-512-2273. Basically, anything we can re-use for another student, we want back.

## K12 MY INFO

My Info allows you to track materials and shipping information for each of the students in your home. You can also communicate directly with your students' teachers through the use of the secure in-system message center (k-mail) that was designed explicitly for use by our students and families.

My Info

Help Logout

Overview

Overview

My Students

Name	School	Grade	School Start Date	School End Date	Material Expected Ship Date	Attendance in Last 30 Days*	Days Since Last Login*	Registration Status

\* This data may be up to one day old.

If any information is incorrect, please [contact your teacher or school](#).

## ANSWERS TO FREQUENTLY ASKED QUESTIONS

### Can K12<sup>®</sup> Customer Support help me solve a computer problem?

***\*Please note that K12 can only help issues related to THEIR computers that you are borrowing, not your own personal computers.***

If you need help solving a computer problem, please call K12<sup>®</sup> Customer Support at **1-866-626-6413**. To help us solve your problem as quickly as possible, please take the following actions before you call:

- Make note of the exact wording of any error messages that pops up on your computer so you can relay it to the Customer Support representative.
- Write down details of the problem, such as how often it happens and what you were doing immediately before the problem occurred. Be prepared to describe the problem in detail. Your description will help the Customer Support representative analyze the problem and suggest a solution.
- Place your phone near your computer so you can easily answer questions about your computer system and the problem you are experiencing.

- Be ready to help the Customer Support representative walk you through a resolution. He or she may ask you to perform some tasks on the computer to get a better picture of what's happening. If you've already performed those steps, tell the Customer Support representative what happened when you performed the steps. You may need to repeat them.
- If you don't understand something, let the Customer Support representative know you don't understand. Don't be afraid to ask questions!

### **How do I choose an Internet Service Provider (ISP)?**

You will access the K12<sup>®</sup> Online School<sup>®</sup> via the Internet, so you will need to choose an Internet Service Provider (ISP). You may choose any ISP you want.

**Setting Up Your Account:** Once you have decided on an ISP, you will need to call the company to set up your service. Most companies have a toll-free number and can help you set up your account over the phone.

**E-mail:** Whatever ISP you choose, be sure the service provides e-mail. Most ISPs provide e-mail and will be happy to help you set up your account.

**Subsidy:** Some of the K12<sup>®</sup> Partner Schools have set up an ISP fee subsidy plan. Please refer to the section on Internet Subsidy in that section of the Parent Orientation Guide.

### **What do I do if my internet goes out?**

Internet is a requirement of TXVA. If your internet temporarily goes out, you will still need to school. We suggest going to a local library, a local business that provides Wifi, or a friend's house to use their internet while you resolve your internet issues. It is expected that all families will have an alternate plan in place for when the internet goes down. Not having internet access is not excuse for not doing school. It's a bit like when a car breaks down—you still have to make arrangements to get the children to school!

### **How do I change my password for the computer itself?**

1. Log on to your computer.
2. Press the Ctrl, Alt, and Delete keys on the keyboard at the same time and then release them.
3. Select "Change Password" from the menu that appears on the screen.
4. Make sure the user name is correct.
5. Make sure the account in the second box is correct (whether it's a domain account or local computer account).
6. Type your old (current) password in the third box.
7. Type your new password in the fourth box.
8. Type your new password again in the fifth box.
9. Click "OK."
10. Click "OK" to acknowledge the message that your password has been changed.
11. Press the Esc button, or click "Cancel" to return to the Windows desktop.

### **How do I clear my cache?**

The cache is the area where your computer stores Web addresses of sites that you have visited recently. Your computer can retrieve an address much faster from the cache than it can

from the Internet. When many addresses are stored in the cache, however, your computer is much less efficient than it is when the cache is empty.

**We recommend that you clear your cache about every two weeks.** Clearing the cache deletes temporary files only. It will not affect any other files on your computer. Because computer systems change frequently and browsers are often updated, we recommend you simply search “how do I clear cache when using \_\_\_\_\_” (insert Explorer, Mozilla, etc into the blank before searching) into a search engine and follow the instructions given.

### **What should I do if my computer doesn't respond when I type or move the mouse?**

One or more applications may be conflicting with the program you are using. Follow these steps to check for other applications that may be running in the background.

1. Press the Ctrl, Alt, and Delete keys on the keyboard at the same time and then release them.
2. Select “Task Manager” from the menu that appears on the screen.
3. Highlight any applications described as "Not Responding."
4. Click the End Task button in the bottom right corner of the window.
5. If another dialog box appears with the message "This program is not responding," click the End Task button in the second box.
6. As a last resort, shut down and restart the computer.

### **I can't hear any sound or play music on my computer. What should I do?**

1. Check your speakers. Are they on? Is the volume turned up?
2. Check the electrical connections. Are they securely connected to the speakers and the computer?
3. Click the volume icon (the one that looks like a speaker) in the group of icons at the bottom of your screen and make sure the volume button is up and the mute box is unchecked. Adjust the volume as necessary, or uncheck the mute box. Then, double-click the volume icon and make sure the rest of the volume controls are up and that the mute boxes are not checked.
4. If you still can't hear any sound or play music on your computer, check the multimedia settings:
  - a. Click “Start” at the bottom left of your screen; select “Settings”; then click “Control Panel.”
  - b. Double-click “Sounds and Multimedia” on the control panel.
  - c. On the Sounds tab, make sure the sound volume control is up and that there is no red line through the speaker icon in the lower-right corner. If there is a red line, click the icon to remove it.
  - d. Click the Audio tab. Look at the “Preferred device” boxes in the Sound Playback, Sound Recording, and MIDI Music Playback Synthesizer sections. The settings should match the name of your computer's sound hardware.
  - e. If you made any changes, click “Apply,” and then click “OK.”
5. If you still have no sound, call or e-mail your teacher in order to document the issue and arrange for further technical support.

### **What can I do if my mouse does not work properly?**

If the pointer on the screen does not move smoothly when you move your mouse, the mouse may need cleaning.



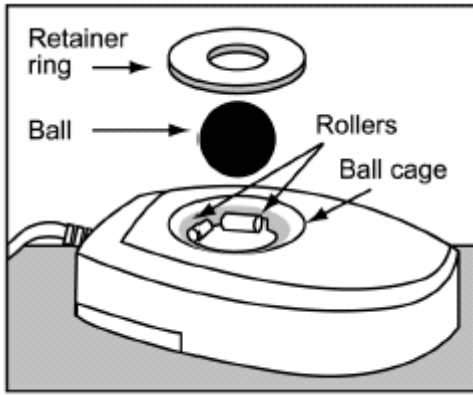

The parts of a typical computer mouse

1. Shut down your computer.
2. Turn the mouse over and twist the retainer ring to the unlocked position.
3. Turn the mouse over so that the retainer ring and ball fall out into your hand.
4. Wash the ball in warm, soapy water and dry it with a clean cloth. Blow carefully into the ball cage to dislodge dust and lint.
5. Look for a buildup of dirt on the rollers inside the ball cage. This buildup usually appears as a stripe running across the middle of the roller. If the rollers are dirty, clean them by using a cotton swab dampened with isopropyl (rubbing) alcohol. Turn the rollers with your finger and continue swabbing them until all the dirt is removed.
6. Remove any fibers from the swab that remain on the rollers.
7. Replace the ball and the retainer ring.
8. Restart your computer.

If you are using a wireless mouse, don't forget to check the batteries. They may be dead.

### **Does my computer need any routine maintenance?**

The following preventive maintenance information will help you keep your computer running smoothly. You can also find tips in the user guide that came with your equipment.

- Keep the computer on a sturdy, flat surface in a clean, dry environment.
- Do not place items on top of the monitor, or cover any of the computer or monitor vents. The vents let air flow over the equipment and keep it from overheating.
- Keep food and drinks away from the computer. Spills and food particles can ruin the mouse, keyboard, and other equipment. Moisture on the power switches or other controls may damage the parts and create an electrical hazard.
- Always disconnect power cords by grasping the plug, not the cord.

### **Periodic cleaning**

It is a good practice to periodically clean the equipment to ensure trouble-free operation. Always turn off your computer, monitor, and any electrical equipment connected to your computer before cleaning.

- **Computer and keyboard:** Use only a mild cleaning solution and a slightly damp cloth.
- **Monitor screen:** Do not use any abrasive cleansers on the monitor screen, as the surface is easily scratched. Gently wipe the screen with a soft, dry cloth or blow on the screen to remove grit and loose particles. Next, use a soft cloth moistened with a nonabrasive liquid glass cleaner. You can also use an antistatic cleaner to slow the buildup of dust.

### **What else do I need to do to keep my computer running smoothly?**

You should run an antivirus scan at least once a month, using the included McAfee Total Protection for Small Business software.

You should run a spyware scan at least twice a month, using one of the spyware-scanning programs mentioned earlier.

You should defragment your hard drive at least once a month. To do so, perform the following steps:

1. Click the **Start** button, and select **All Programs**
2. Select **Accessories**
3. Select **System Tools**
4. Select **Disk Defragmenter**
5. Highlight your hard drive (C:) and click the **Analyze** button
6. If you get a message saying you do not need to defragment the hard drive, close the application. If the message says to defragment the hard drive, click the **Defragment** button.

**Note:** Your computer will run very slowly during the defragmentation process. It's best to schedule a time to defragment when you're not planning on using the computer. Do not turn off your computer or let it go into Standby mode while the disk is defragmenting.

### **Where can I go to get more help?**

K12<sup>®</sup> Customer Care is the first point of contact for parents and students who need computer help. Call 1-866-626-6413 to speak with K12<sup>®</sup> Technical Support.

---

## **BLACKBOARD TIPS AND TRICKS**

### **Setting up Your Computer for Blackboard**

The first time you log into an Blackboard classroom, it can take up to 30 minutes to download the software so be sure to login with plenty of time allotted.

**Please note that if you are on dial up, Blackboard is not going to work properly.**

After you have successfully installed the software onto your computer, you may want to view some brief recorded orientations.

<http://www.blackboard.com/Platforms/Collaborate/Services/On-Demand-Learning-Center/Web-Conferencing.aspx>

### **Problems With Wireless Connection and Blackboard**

When using Blackboard and you continue to lose connections, you should attempt the following suggested fixes (attempt them in this order):

- 1) Be sure you are not too far from your router
- 2) Be sure there is no problem with your Internet. Check another computer to see if the Internet is still active.
- 3) While in Blackboard, go to TOOLS>PREFERENCES>then choose the lowest connection speed (ie. 28.8). If this works, you can continue to raise the speed until you begin to get kicked off again.

- 4) Close all applications that are not being used during Blackboard. Outlook continues to check for email and uses bandwidth. The fewer applications you have open, the better the program works.
- 5) Empty your Java cache. This will also help with most Blackboard problems such as the microphone or whiteboard not working properly.
- 6) Delete old versions and updates to Java and get the new version. Go to START>CONTROL PANEL>ADD/REMOVE PROGRAMS>then delete all Java applications and updates. They can be identified by the little coffee cup. Then go to [www.java.com](http://www.java.com) and get the latest version.
- 7) Hard wire your computer to the Internet. This allows for much more information to be sent to your computer and keeps the signal strength constant. When hardwired to the Internet, you should disable your wireless card.

It is important to note that when using a wireless connection, your signal and bandwidth will fluctuate, even though your wireless connection may say “excellent”. When a wireless connection says excellent it is ONLY notifying you of the connection to the Wireless Access point (router: i.e. Linksys, Netgear, etc). You can have an excellent connection to your router and still NO Internet connection. This does not constitute a wireless issue.

### Clearing the Java Cache

Clearing the JAVA cache should help clear up many problems that occur in Blackboard, such as Audio problems (choppy audio, echo) and components not fully installed.

- Click on the **Start** menu and select **Control Panel** (Settings -> Control Panel)

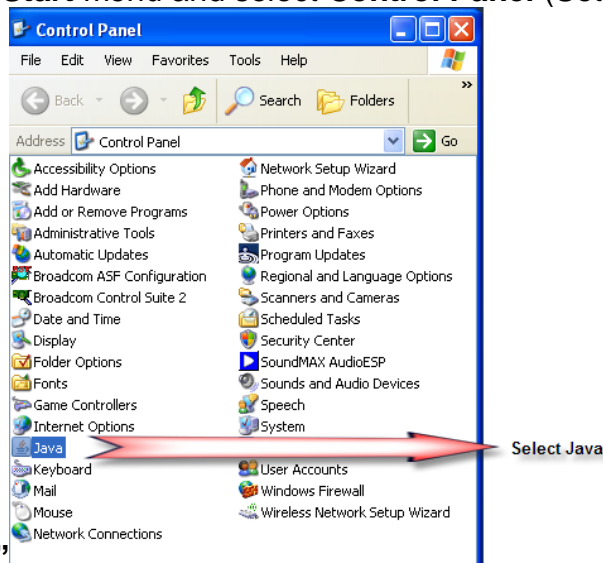

- Open “**Java**”
- Click the “**Settings**” button.



- Click the “Delete Files” Button.

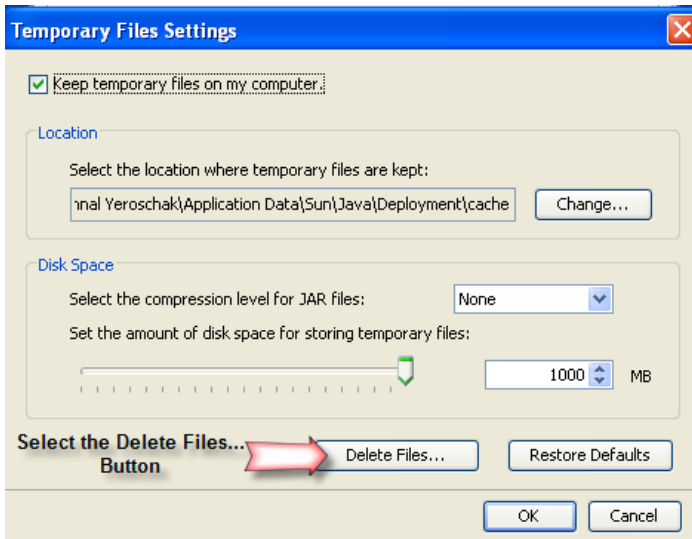

- This will open a “Delete Temporary Files” dialog box. Select “OK” for deleting “Applications and Applets” and “Trace and Log Files.”

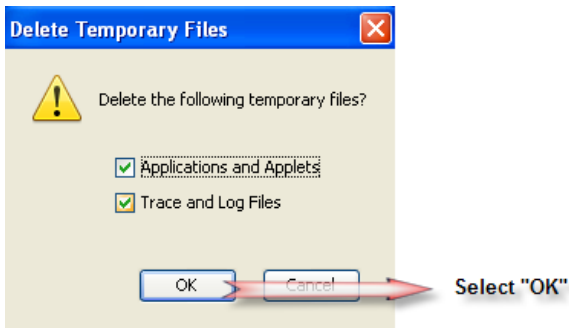

- Close the Java Control Panel
- 

## **MOTIVATING STUDENTS**

Many students begin the school year excited about their new classes. However, at some point students may procrastinate, and do everything possible to avoid completing their assignments. Many students (and parents) experience difficulty becoming and remaining motivated. Below, parents can find suggestions, incentives, and resources for maintaining enthusiasm and excitement about learning.

### **Do:**

Be consistent.

- o Stick to a schedule.
- o Attend outings offered throughout the year.
- o Send in required work samples.

Involve your student in creating and completing a daily schedule.

- o Discuss courses and create a plan to work toward goals set for the year.
- o Discuss accomplishments each day.

Create an inviting work environment.

- o Provide a space for your student to work.
- o Keep a space for ongoing projects.
- o Keep materials where they are easily accessible.
- o Make sure you have a working microphone
- o Eliminate distractions.

Focus on the positive.

- o Become your student's learning partner.
- o Offer incentives for your student to complete his/her work.
- o Enjoy a fun activity once a goal is achieved.

### **Don't:**

- o Leave school up to your student alone; he/she needs your help on a daily basis because you are their primary learning coach. Your child's success depends on this partnership.
- o Blame your child if schooling does not run smoothly. Step back, take a break, and evaluate what is working and what isn't. Talk to your child and his/her homeroom teacher to discuss possible solutions. Your child's education is paramount to all involved.

**Incentives:** Incentives allow students to control whether or not they earn rewards. Once incentives are earned, they are not to be taken away. Below are some examples of incentives, but parents can be creative and determine what works best for their families.

- o Buy a set amount of game tokens. Designate a cup or bowl for collecting earned game tokens. Tell your student that every assignment he/she completes without complaining, earns him/her 1-2 tokens (or whatever amount you decide). Indicate on a calendar the day that your student may use the tokens for a reward of your choice.
- o Prepare a "treasure chest" and stock it with various prizes that your student has helped you select. Students can place stickers for completed lessons on small incentive chart that can be

purchased at a local teacher supply store. Once the chart is full, the student may select a prize from the treasure chest.

o When schooling multiple children, a “happy bean jar” may work wonders. Obtain a glass jar and a bag of beans. When students work together cooperatively, place a bean in the jar. Once the bean jar is full, reward students with an item or activity of their choice.

o Create a chart that lists activities that a student can complete to earn tickets. For instance: getting himself/herself up and ready for school on time= 2 tickets, or completing an extra assignment = 5 tickets, staying on track for an entire week in his or her OLS assignments=5 tickets, etc. Students can redeem tickets for free time to do what they like. Students can even redeem tickets for a bigger reward: lunch or dinner out, going to a movie, bowling, or the mall. These types of rewards are more motivating for the older students.

Along with the do-and-don't checklist and the aforementioned incentives, parents may find information about motivating students by searching the Internet. Some well-established philosophies and strategies to motivate students are listed in book form below and can be found at your local library:

o Logical and Natural Consequences: Dinkmeyer and McKay

o PAT-“Preferred Activity Time:” Fred Jones, author of *Positive Classroom Behavior*

o Discipline with Love and Logic: Foster Cline and Jim Fay

o Choice Theory and Control Theory: William Glasser

---

## **PARENT TIPS AND TRICKS**

Some of the most valuable tips and tricks are provided by experienced TXVA families. Below is a list of suggestions and advice that may work for your family too.

### **Starting School:**

- Give yourself time to get familiar with the material, and develop a daily schedule based off your OLS requirements. It is very helpful to refer to your child's daily schedule when setting up a schedule.
- Maintain open communication with teachers and make schooling your priority.
- Persevere as a family. Do not allow yourself or your family to become overwhelmed. Work cooperatively and patiently to troubleshoot challenges (i.e., computer or software problems, lifestyle change, etc.).
- Understand that some families need up to a year to become completely comfortable with the online school model. Over time, the curriculum and instructional techniques will become more familiar and easier to understand.
- Keep in mind that parents who have no schooling at home experience may be surprised to discover that schooling at home is time consuming—particularly in the first two or three months as everyone acclimates to the new arrangement. Nevertheless, the reward of knowing that the nature of TXVA's program leads to high-quality education far outweighs the challenges.
- Check kmail daily and thoroughly read the information sent. This is our main form of communication, and you will have correspondence from many departments.

**Organization:**

- Try not to be overwhelmed when the abundant school materials arrive, which you need to open and inventory. Once the school year's materials are organized, you and your student will be reassured that you will tackle only one lesson at a time and use only the resources required for each lesson.
- Get ready for the school year and organize your workspace as early as possible. Consider using simple hanging files or binders for the student's finished work organized by subject, and separate a hanging file for monthly work sample submissions.
- Establish a reward system based on daily attitude and activity. Verbal praise is more effective than a trip to the mall. (See the previous section that covers motivation.)
- Daily schedules are imperative for your child's online learning success. Establish a schedule and try to stick to it.
- Obtain a notebook and write down questions for discussion with the teacher. Leave space to record responses.

**Preparation:**

- Prepare all of the materials and look at the OLS daily and/or weekly plan the night before.
- Print out the weekly/daily plan. Some students prefer to work through courses in the order of their choice and feel good about themselves as they cross off the completed coursework.
- Plan ahead by preparing worksheets and documents for the student. Tear out and staple workbook pages into small sections. Mark pages to read with sticky notes.
- Visit the "Advance Preparation" option every day to optimize planning. Science lessons may require some advance preparation.

**Coaching:**

- Keep in mind that parents may modify lessons. If the student already demonstrates mastery of the objectives, he/she may choose to complete the lesson/unit assessment.
- Strive to begin school each day at a specified time. Stay on top of your schedule. Catching up can be challenging.
- You might choose to post a motto in the classroom area of your house to motivate. Some suggestions: "Where there's a will, there's a way." or "Just do it".

**Lessons and Courses:**

- Understand the percentages of assignments that students need to complete on time so their progress will be kept up to date.
- Keep in mind those students who start the school at mid-year still must reach mastery in their courses to be promoted the following school year. The lessons will be prorated to match his or date of enrollment.
- Remember that optional lessons in the OLS are not figured into the percentage of core lessons used to calculate course promotion eligibility.
- Understand the difference between viewing *all lessons* and *core lessons* on the progress screen.
- Keep in mind that each student has a unique readiness level and cannot be compared to other students. The K12<sup>®</sup> curriculum is rigorous and students often place one or two grade levels below in math and language arts.
- Adjust the *schedule set-up* to ensure the student is on track to finish the course by the school end date, but be reasonable in the expectations you set. Talk to your

homeroom teacher for guidance with this, and with the student—particularly the older ones.

**General:**

- Use the <http://txva.k12start.com> site (particularly The Parent Network area)
  - Attend a parent training or chat session. They are very informative.
  - Attend as many outings as possible. Meeting other families and students helps families create a sense of community and belonging, and provides them with the opportunity to share experiences.
  - Make marking progress and attendance in the OLS *daily* a habit. If you are taking a vacation day, mark that in the “schedule set up” area of the OLS and let your teacher know you’ll be out.
  - Make the scheduled teacher conferences a priority. Your teacher is an important component of this program and can really contribute a lot. Please take advantage of their professionalism and willingness to help.
- 

## **WORKING PARENT TIPS AND TRICKS**

We know that some parents/learning coaches need to work part-time or even full-time. Below are some suggestions for you:

- Always plan ahead. Print up the weekly plan. Use it as a way for your student and you to keep track of what work is getting done daily.
- Have an in box for your child to turn in the work they complete during the day.
- Keep a log. Use a notebook or computer paper for your child to record the time they spent working on each lesson. (You can also use the weekly plan to have your child put down times and check off what they completed).
- Check in with text messages or calls during the day. For example, coffee break is at 9:00- text or call for wake up call; 12-1:00 is lunch- check in call; 3:00- check in call.
- Check k-mails and OLS progress when you have breaks. It only takes a couple of minutes. If you check progress throughout the day, you can see what your child has started working on or hasn’t started working on. If you see no work, then give a check in call. This might be tough at the beginning but if you stay consistent, it will pay off and your child will get on a regular schedule of working and knowing that you are following through with checking in.
- Set up consequences when work is not done and stick to them.
- Have a time set aside to work with your child DAILY on subjects they struggle with or subjects that you LOVE working on with your child.
- Set aside a time every day to check work that was completed during the day. Give feedback and encouragement. Be prepared to “re-teach” a concept, reach out to the HR teacher for assistance if needed or talk to student about making a plan for attending tutoring sessions.
- Review student work log and record attendance in the OLS every night.
- Be Realistic- it is not always easy at the beginning. It is okay to change up the schedule, try out new ways to work on lessons and ask for help.





# LIABILITY RELEASE

This will need to be signed at all TXVA outings in order to participate.

## LIABILITY RELEASE AGREEMENT

**Minor's Legal Name (Print)** \_\_\_\_\_ **(If there is more than one child per family participating, please provide their legal name(s)):** \_\_\_\_\_ (collectively referred to as "Minor") wishes to participate in ("Activity")

sponsored by K12 Inc., a Delaware corporation ("K12"). K12 and the undersigned parent or legal guardian of Minor agree that the Activity may pose risks, including possible illness, injury, as well as similar and dissimilar risks ("Risks"). The undersigned is fully aware of the Risks and other hazards inherent in the Activity and is participating in the Activity voluntarily and assumes the Risks and all other risks of loss, damage, or injury that may be sustained while participating in the activity. K12 makes no representations or claims as to the condition or safety of the land, structures, transportation or surroundings that may be involved in the Activity, whether or not owned, leased, operated or maintained by K12. It is understood that K12 does NOT provide any insurance coverage for the Minor's person or property, and Minor's parent (s) or guardian (s) acknowledge that they are responsible for the Minor's safety and the Minor's own health care needs, and for the protection of the Minor's property. In exchange for allowing the Minor to participate in these K12 Activities, the Minor, by and through the undersigned, the undersigned, and their respective heirs, personal representatives and estates agree(s) to release from liability and hold harmless K12 and any agent, officer or employee of K12 acting within the scope of their duties for any injury to the Minor's person or damage to the Minor's property. I authorize K12 to take any action, including seeking medical care, necessary in its judgment if I am not present or reachable in the event of an emergency. The undersigned acknowledges that as a part of this Release he or she shall be 100% liable to pay for all medical expenses resulting or to result from any injury incurred during, or as a result of, participation in the Activity. If any term of this agreement or the application to any person or circumstance shall, to any extent, be invalid or unenforceable, the remainder shall not be affected thereby, and each and every remaining term of this agreement shall be valid and enforced to the fullest extent permitted by law. In the event of any need to enforce this agreement, K12 shall be entitled to its attorney fees and costs. This agreement will be governed by Texas law. I, the undersigned, state that I am the parent or legal guardian of the Minor. I have fully read and understand the above terms and conditions and that they apply to said Minor and to myself, and that no oral representations, statements or inducements apart from the foregoing written agreement have been made to the undersigned. This document is binding on myself, the said Minor, and any person suing on behalf of said Minor.

Address: \_\_\_\_\_

Parent/Guardian Name (Please print) \_\_\_\_\_

Signed \_\_\_\_\_

Date \_\_\_\_\_

# PHOTO RELEASE DOCUMENT

This will be available at all TXVA outings.

## Photograph, Testimonial and Interview Release

In exchange for good and valuable consideration, the receipt and sufficiency of which is hereby acknowledged, I hereby grant to K12 Inc., its legal representatives, successors and assigns, and those acting with their authority and permission (collectively, "K12") the right and permission to use, re-use, publish, re-publish, and copyright (in K12's own name and otherwise) testimonials (written by me or attributed to me), interviews (written by me or attributed to me), and photographic portraits, pictures, images and/or likenesses of me or in which I may be included (in whole or in part, or composite, or distorted in character or form, without restriction as to changes or alterations), in conjunction with my own or a fictitious name, made through any medium, and in any and all media now or hereafter known throughout the world in perpetuity. All rights, licenses and privileges herein granted to K12 are irrevocable and not subject to rescission, restraint or injunction under any circumstances. I hereby waive any right that I may have to inspect or approve the finished product, or products and the advertising copy or other matter that may be used in connection therewith or the use to which it may be applied.

I hereby release, discharge and agree to save harmless K12 from and against any claims, damages or liability arising from or related to the use of any of the aforementioned material, including but not limited to any liability by virtue of any editing, blurring, distortion, alteration, optical illusion, or use in composite form, whether intentional or otherwise, that may occur or be produced in the taking, recording, editing, processing, publishing or distribution of said testimonials, interviews, pictures, portraits, images and/or likenesses including, without limitation, any claims for defamation, invasion of privacy, right of publicity or violation of any other right.

I hereby acknowledge that the compensation provided does not include any monetary compensation or tangible goods or services and that none are due to me for granting this release.

I hereby warrant that I am of full age and have the right to contract in my own name. I have read this Release prior to its execution, and I am fully familiar with the contents thereof. This Release shall be binding upon me and my heirs, legal representatives, and assigns.

If signing as parent or guardian, I hereby warrant and represent I am the parent or legal guardian of the named minor and have authority to and do hereby consent to this Release on his/her behalf and will be responsible for any damages incurred by K12 resulting from the minor's breach or renunciation of this Release.

Name (print): \_\_\_\_\_

Signature of parent or guardian (as to minors):

Address: \_\_\_\_\_

# MY LOGIN INFORMATION & PASSWORDS

Print, fill out, and keep in a safe place

Remember: LC log in information should not be accessible to the student.

**Learning Coach OLS login:**

ID: \_\_\_\_\_ Password: \_\_\_\_\_

**Student OLS login:**

ID: \_\_\_\_\_ Password: \_\_\_\_\_

**Study Island login:**

ID: \_\_\_\_\_

Password: \_\_\_\_\_

**Online Gradebook login:**

ID: \_\_\_\_\_

Password: \_\_\_\_\_

**Scantron Log in:**

Site Number: 76-9302-7096 (must use hyphens) ID: \_\_\_\_\_

**Student ID #:** \_\_\_\_\_

**Homeroom Teacher's Name and Information:**

Teacher's Name: \_\_\_\_\_

Phone Number: \_\_\_\_\_

**Additional log in and password information:**

Website	Login ID	Password

# ACKNOWLEDGEMENT OF THIS DOCUMENT

Dear Parents and Students:

You have just reviewed the Texas Virtual Academy Parent Orientation Guide. We have attempted to cover all the important rules, regulations, and procedures for which you are responsible during this school year. Your success at the Academy is equal to your effort and desire. ***The timestamp that shows when you opened the email with this Parent Orientation Guide attached will serve as your acknowledgement and understanding of this document.***

---

## CLASS CONNECT SCHEDULE

### Grades 3-5:

	Monday	Tuesday	Wednesday	Thursday	Friday	
8:30	MMM	Math 3 TT (8:30 - 9)	Reading 5 TT (8:30 - 9)	Math 3 TT (8:30 - 9)		
9:00		Math 3 (9 - 10)	PE/Health 3 Reading 5 (9 - 10)	Math 3 (9 - 10)	Art/Intro to Music 3&4 GUM/W 5 (9 - 10)	
9:30						
10:00		Intermed 1 Music (Gr. 4)--Recorder Practice Math TT 5 (10 - 10:30)	Writing 4 TT (10 - 10:30)	Math TT 5 (10 - 10:30)	GUM TT 4 (10 - 10:30)	
10:30		Weekly Staff Meetings 10:30-12:00/12:30	Math 5 (10:30 - 11:30)	Writing 4 PE/Health 5 (10:30 - 11:30)	Math 5 (10:30 - 11:30)	GUM 4 Art/Music 5 (10:30 - 11:30)
11:00						
11:30	Math 4 TT Science 5 TT (11:30-12)		Reading 3 TT (11:30-12)	Math 4 TT Science 5 TT (11:30-12)		
12:00	Math 4 Science 5 (12 - 1)		Reading 3 PE/Health 4 (12 - 1)	Math 4 Science 5 (12 - 1)	GUM/W 3 Art 4/Intermediate I Music (12 - 1)	
12:30						
1:00			Reading 4 TT (1 - 1:30)			
1:30		SS 3 Science 4 (1:30 - 2:30)	Reading 4 SS 5 (1:30 - 2:30)	Science 3 SS 4 (1:30 - 2:30)		
2:00						
2:30						

## Grades 6-8:

	Monday	Tuesday	Wednesday	Thursday	Friday
8:30	MMM	Math 6 TT (8:30 - 9)	Reading 7 TT Art 8 (8:30 - 9)	Math 6 TT (8:30 - 9)	
9:00		Math 6 ( 9 - 10)	Art/Music 6 Reading 7 (9 - 10)	Math 6 ( 9 - 10)	PE 7 Technology 8 (9 - 10)
9:30					
10:00		Math TT 7 (10 - 10:30)	Reading TT 8 (10 - 10:30)	Math TT 7 Writing 8 TT (10 - 10:30)	PE/Health 6 (10 - 11) GUM TT 8 (10 - 10:30)
10:30	Weekly Staff Meetings 10:30-12:00/12:30	Math 7 (10:30 - 11:30)	GUM 6 Art/Music 7 Reading 8 (10:30 - 11:30)	Math 7 Writing 8 (10:30 - 11:30)	Technology 7 GUM 8 (10:30 - 11:30)
11:00					
11:30		Math 8 TT (11:30-12)	Writing 7 TT (11:30 - 12)	Math 8 TT (11:30-12)	GUM 7 TT (11:30 - 12)
12:00		Science 6 Math 8 (12 - 1)	Writing 7 (12 - 1)	Science 7 Math 8 (12 - 1)	Technology 6 GUM 7 PE/Health 8 (12 - 1)
12:30					
1:00		Science 8 TT (1 - 1:30)	Reading 6 TT SS 8 TT (1 - 1:30)	Science 8 TT (1 - 1:30)	SS 8 TT (1 - 1:30)
1:30		SS 6 Science 8 (1:30 - 2:30)	Reading 6 SS 8 (1:30 - 2:30)	SS 7 Science 8 (1:30 - 2:30)	Writing/GUM 6 SS 8 (1:30 - 2:30)
2:30		French/Spanish Year 1 (2:30-3:30)	French/Spanish Year 2 (2:30-3:30)		
3:30					

## PROGRESS/ATTENDANCE PACING CHARTS

### Progress and Attendance Guidelines-Quarter 1

STUDENT START DATES DOWN	SCHOOL DAYS ACROSS	8/29	9/5	9/12	9/19	9/26	10/3	10/10	10/17	QTR 1 10/24
8/25	PROGRESS	NA	2%	5%	8%	11%	14%	16%	19%	22%
	HOURS	30	54	84	114	144	174	204	234	264
	DAYS	5	9	14	19	24	29	34	39	44
9/2	PROGRESS	NA	NA	2%	5%	8%	11%	13%	16%	19%
	HOURS	NA	24	54	84	114	144	174	204	234
	DAYS	NA	4	9	14	19	24	29	34	39
9/8	PROGRESS	NA	NA	NA	3%	6%	9%	11%	14%	17%
	HOURS	NA	NA	30	60	90	120	150	180	210
	DAYS	NA	NA	5	10	15	20	25	30	35
9/15	PROGRESS	NA	NA	NA	NA	3%	6%	8%	11%	14%
	HOURS	NA	NA	NA	30	60	90	120	150	180
	DAYS	NA	NA	NA	5	10	15	20	25	30
9/22	PROGRESS	NA	NA	NA	NA	NA	3%	5%	8%	11%
	HOURS	NA	NA	NA	NA	30	60	90	120	150
	DAYS	NA	NA	NA	NA	5	10	15	20	25
9/29	PROGRESS	NA	NA	NA	NA	NA	NA	2%	5%	8%
	HOURS	NA	NA	NA	NA	NA	30	60	90	120
	DAYS	NA	NA	NA	NA	NA	5	10	15	20
10/6	PROGRESS	NA	NA	NA	NA	NA	NA	NA	2%	5%
	HOURS	NA	NA	NA	NA	NA	NA	30	60	90
	DAYS	NA	NA	NA	NA	NA	NA	5	10	15
10/13	PROGRESS	NA	NA	NA	NA	NA	NA	NA	NA	3%
	HOURS	NA	NA	NA	NA	NA	NA	NA	30	60
	DAYS	NA	NA	NA	NA	NA	NA	NA	5	10
10/20	PROGRESS	NA	NA	NA	NA	NA	NA	NA	NA	NA
	HOURS	NA	NA	NA	NA	NA	NA	NA	NA	30
	DAYS	NA	NA	NA	NA	NA	NA	NA	NA	5

## Progress and Attendance Guidelines-Quarter 2

STUDENT START DATES DOWN	SCHOOL DAYS ACROSS	10/31	11/7	11/14	11/21	11/25	12/5	12/12	12/19	1/9	End of QTR 2 1/15
8/25	PROGRESS	25%	28%	31%	34%	35%	38%	41%	44%	47%	50%
	HOURS	294	324	354	384	396	426	456	486	516	540
	DAYS	49	54	59	64	66	71	76	81	86	90
9/2	PROGRESS	22%	25%	28%	31%	32%	35%	38%	41%	44%	47%
	HOURS	264	294	324	354	366	396	426	456	486	510
	DAYS	44	49	54	59	61	66	71	76	81	85
9/8	PROGRESS	20%	23%	26%	29%	30%	33%	36%	39%	42%	44%
	HOURS	240	270	300	330	342	372	402	432	462	486
	DAYS	40	45	50	55	57	62	67	72	77	81
9/15	PROGRESS	17%	20%	23%	26%	27%	30%	33%	36%	39%	41%
	HOURS	210	240	270	300	312	342	372	402	432	456
	DAYS	35	40	45	50	52	57	62	67	72	76
9/22	PROGRESS	14%	17%	20%	23%	24%	27%	30%	33%	36%	38%
	HOURS	180	210	240	270	282	312	342	372	402	426
	DAYS	30	35	40	45	47	52	57	62	67	71
9/29	PROGRESS	11%	14%	17%	20%	21%	24%	27%	30%	33%	35%
	HOURS	150	180	210	240	252	282	312	342	372	396
	DAYS	25	30	35	40	42	47	52	57	62	66
10/6	PROGRESS	8%	11%	14%	17%	18%	21%	24%	27%	30%	32%
	HOURS	120	150	180	210	222	252	282	312	342	366
	DAYS	20	25	30	35	37	42	47	52	57	61
10/13	PROGRESS	6%	9%	12%	15%	16%	19%	22%	25%	28%	31%
	HOURS	90	120	150	180	192	222	252	282	312	336
	DAYS	15	20	25	30	32	37	42	47	52	56
10/20	PROGRESS	3%	6%	9%	12%	13%	16%	19%	22%	25%	28%
	HOURS	60	90	120	150	162	192	222	252	282	306
	DAYS	10	15	20	25	27	32	37	42	47	51
10/27	PROGRESS	NA	3%	6%	9%	10%	13%	16%	19%	22%	25%
	HOURS	30	60	90	120	132	162	192	222	252	276
	DAYS	5	10	15	20	22	27	32	37	42	46



<b>STUDENT START DATES DOWN</b>	<b>SCHOOL DAYS ACROSS</b>	<b>10/31</b>	<b>11/7</b>	<b>11/14</b>	<b>11/21</b>	<b>11/25</b>	<b>12/5</b>	<b>12/12</b>	<b>12/19</b>	<b>1/9</b>	<b>End of QTR 2 1/15</b>
<b>11/3</b>	<b>PROGRESS</b>	NA	NA	3%	6%	7%	10%	13%	16%	19%	22%
	<b>HOURS</b>	NA	30	60	90	102	132	162	192	222	246
	<b>DAYS</b>	NA	5	10	15	17	22	27	32	37	41
<b>11/10</b>	<b>PROGRESS</b>	NA	NA	NA	3%	4%	7%	10%	13%	16%	19%
	<b>HOURS</b>	NA	NA	30	60	72	102	132	162	192	216
	<b>DAYS</b>	NA	NA	5	10	12	17	22	27	32	36
<b>11/17</b>	<b>PROGRESS</b>	NA	NA	NA	NA	1%	4%	7%	10%	13%	16%
	<b>HOURS</b>	NA	NA	NA	30	42	72	102	132	162	186
	<b>DAYS</b>	NA	NA	NA	5	7	12	17	22	27	31
<b>11/24</b>	<b>PROGRESS</b>	NA	NA	NA	NA	NA	1%	4%	7%	10%	13%
	<b>HOURS</b>	NA	NA	NA	NA	12	42	72	102	132	156
	<b>DAYS</b>	NA	NA	NA	NA	2	7	12	17	22	26
<b>12/1</b>	<b>PROGRESS</b>	NA	NA	NA	NA	NA	NA	3%	6%	9%	11%
	<b>HOURS</b>	NA	NA	NA	NA	NA	30	60	90	120	144
	<b>DAYS</b>	NA	NA	NA	NA	NA	5	10	15	20	24
<b>12/8</b>	<b>PROGRESS</b>	NA	NA	NA	NA	NA	NA	NA	3%	6%	8%
	<b>HOURS</b>	NA	NA	NA	NA	NA	NA	30	60	90	114
	<b>DAYS</b>	NA	NA	NA	NA	NA	NA	5	10	15	19
<b>12/15</b>	<b>PROGRESS</b>	NA	NA	NA	NA	NA	NA	NA	NA	3%	5%
	<b>HOURS</b>	NA	NA	NA	NA	NA	NA	NA	30	60	84
	<b>DAYS</b>	NA	NA	NA	NA	NA	NA	NA	5	10	14
<b>1/5</b>	<b>PROGRESS</b>	NA	NA	NA	NA	NA	NA	NA	NA	NA	2%
	<b>HOURS</b>	NA	NA	NA	NA	NA	NA	NA	NA	30	54
	<b>DAYS</b>	NA	NA	NA	NA	NA	NA	NA	NA	5	9
<b>1/12</b>	<b>PROGRESS</b>	NA	NA	NA	NA	NA	NA	NA	NA	NA	NA
	<b>HOURS</b>	NA	NA	NA	NA	NA	NA	NA	NA	NA	24
	<b>DAYS</b>	NA	NA	NA	NA	NA	NA	NA	NA	NA	4

## Progress and Attendance Guidelines-Quarter 3

STUDENT START DATES DOWN	SCHOOL DAYS ACROSS	1/23	1/30	2/6	2/13	2/20	2/27	3/6	3/13	3/27	End of QTR 3 3/31
8/25	PROGRESS	52%	55%	58%	60%	62%	65%	68%	71%	74%	74%
	HOURS	564	594	624	654	678	708	738	768	798	810
	DAYS	94	99	104	109	113	118	123	128	133	135
9/2	PROGRESS	49%	52%	55%	57%	59%	62%	65%	68%	71%	71%
	HOURS	534	564	594	624	648	678	708	738	768	780
	DAYS	89	94	99	104	108	113	118	123	128	130
9/8	PROGRESS	47%	50%	53%	54%	57%	60%	63%	66%	69%	69%
	HOURS	510	540	570	600	624	654	684	714	744	756
	DAYS	85	90	95	100	104	109	114	119	124	126
9/15	PROGRESS	44%	47%	50%	51%	54%	57%	60%	63%	66%	66%
	HOURS	480	510	540	570	594	624	654	684	714	726
	DAYS	80	85	90	95	99	104	109	114	119	121
9/22	PROGRESS	41%	44%	47%	49%	51%	54%	57%	60%	63%	63%
	HOURS	450	480	510	540	564	594	624	654	684	696
	DAYS	75	80	85	90	94	99	104	109	114	116
9/29	PROGRESS	38%	41%	44%	46%	48%	51%	54%	57%	60%	60%
	HOURS	420	450	480	510	534	564	594	624	654	666
	DAYS	70	75	80	85	89	94	99	104	109	111
10/6	PROGRESS	35%	38%	41%	43%	45%	48%	51%	54%	57%	57%
	HOURS	390	420	450	480	504	534	564	594	624	636
	DAYS	65	70	75	80	84	89	94	99	104	106
10/13	PROGRESS	33%	36%	39%	41%	43%	46%	49%	52%	55%	55%
	HOURS	360	390	420	450	474	504	534	564	594	606
	DAYS	60	65	70	75	79	84	89	94	99	101
10/20	PROGRESS	30%	33%	36%	38%	40%	43%	46%	49%	52%	52%
	HOURS	330	360	390	420	444	474	504	534	564	576
	DAYS	55	60	65	70	74	79	84	89	94	96
10/27	PROGRESS	27%	30%	33%	35%	37%	40%	43%	46%	49%	49%
	HOURS	300	330	360	390	414	444	474	504	534	546
	DAYS	50	55	60	65	69	74	79	84	89	91
11/3	PROGRESS	24%	27%	30%	32%	34%	37%	40%	43%	46%	46%
	HOURS	270	300	330	360	384	414	444	474	504	516
	DAYS	45	50	55	60	64	69	74	79	84	86

<b>STUDENT START DATES DOWN</b>	<b>SCHOOL DAYS ACROSS</b>	<b>1/23</b>	<b>1/30</b>	<b>2/6</b>	<b>2/13</b>	<b>2/20</b>	<b>2/27</b>	<b>3/6</b>	<b>3/13</b>	<b>3/27</b>	<b>End of QTR 3 3/31</b>
<b>11/10</b>	<b>PROGRESS</b>	21%	24%	27%	29%	31%	34%	37%	40%	43%	43%
	<b>HOURS</b>	240	270	300	330	354	384	414	444	474	486
	<b>DAYS</b>	40	45	50	55	59	64	69	74	79	81
<b>11/17</b>	<b>PROGRESS</b>	18%	21%	24%	26%	28%	31%	34%	37%	40%	40%
	<b>HOURS</b>	210	240	270	300	324	354	384	414	444	456
	<b>DAYS</b>	35	40	45	50	54	59	64	69	74	76
<b>11/24</b>	<b>PROGRESS</b>	15%	18%	21%	23%	25%	28%	31%	34%	37%	37%
	<b>HOURS</b>	180	210	240	270	294	324	354	384	414	426
	<b>DAYS</b>	30	35	40	45	49	54	59	64	69	71
<b>12/1</b>	<b>PROGRESS</b>	14%	17%	20%	22%	24%	27%	30%	33%	36%	36%
	<b>HOURS</b>	168	198	228	258	282	312	342	372	402	414
	<b>DAYS</b>	28	33	38	43	47	52	57	62	67	69
<b>12/8</b>	<b>PROGRESS</b>	11%	14%	17%	19%	21%	24%	27%	30%	33%	33%
	<b>HOURS</b>	138	168	198	228	252	282	312	342	372	384
	<b>DAYS</b>	23	28	33	38	42	47	52	57	62	64
<b>12/15</b>	<b>PROGRESS</b>	8%	11%	14%	16%	18%	21%	24%	27%	30%	30%
	<b>HOURS</b>	108	138	168	198	222	252	282	312	342	354
	<b>DAYS</b>	18	23	28	33	37	42	47	52	57	59
<b>1/5</b>	<b>PROGRESS</b>	5%	8%	11%	13%	15%	18%	21%	24%	27%	27%
	<b>HOURS</b>	78	108	138	168	192	222	252	282	312	324
	<b>DAYS</b>	13	18	23	28	32	37	42	47	52	54
<b>1/12</b>	<b>PROGRESS</b>	2%	5%	8%	10%	12%	15%	18%	21%	24%	24%
	<b>HOURS</b>	48	78	108	138	162	192	222	252	282	294
	<b>DAYS</b>	8	13	18	23	27	32	37	42	47	49
<b>1/20</b>	<b>PROGRESS</b>	NA	2%	5%	7%	10%	13%	16%	19%	22%	22%
	<b>HOURS</b>	24	54	84	114	138	168	198	228	258	270
	<b>DAYS</b>	4	9	14	19	23	28	33	38	43	45
<b>1/26</b>	<b>PROGRESS</b>	NA	NA	3%	5%	7%	10%	13%	16%	19%	19%
	<b>HOURS</b>	NA	30	60	90	114	144	174	204	234	246
	<b>DAYS</b>	NA	5	10	15	19	24	29	34	39	41

<b>STUDENT START DATES DOWN</b>	<b>SCHOOL DAYS ACROSS</b>	<b>1/23</b>	<b>1/30</b>	<b>2/6</b>	<b>2/13</b>	<b>2/20</b>	<b>2/27</b>	<b>3/6</b>	<b>3/13</b>	<b>3/27</b>	<b>End of QTR 3 3/31</b>
<b>2/2</b>	<b>PROGRESS</b>	NA	NA	NA	2%	4%	7%	10%	13%	16%	16%
	<b>HOURS</b>	NA	NA	30	60	84	114	144	174	204	216
	<b>DAYS</b>	NA	NA	5	10	14	19	24	29	34	36
<b>2/9</b>	<b>PROGRESS</b>	NA	NA	NA	NA	1%	4%	7%	10%	13%	13%
	<b>HOURS</b>	NA	NA	NA	30	54	84	114	144	174	186
	<b>DAYS</b>	NA	NA	NA	5	9	14	19	24	29	31
<b>2/17</b>	<b>PROGRESS</b>	NA	NA	NA	NA	NA	2%	5%	8%	11%	11%
	<b>HOURS</b>	NA	NA	NA	NA	24	54	84	114	144	156
	<b>DAYS</b>	NA	NA	NA	NA	4	9	14	19	24	26
<b>2/23</b>	<b>PROGRESS</b>	NA	NA	NA	NA	NA	NA	3%	6%	9%	9%
	<b>HOURS</b>	NA	NA	NA	NA	NA	30	60	90	120	132
	<b>DAYS</b>	NA	NA	NA	NA	NA	5	10	15	20	22
<b>3/2</b>	<b>PROGRESS</b>	NA	NA	NA	NA	NA	NA	NA	3%	6%	6%
	<b>HOURS</b>	NA	NA	NA	NA	NA	NA	30	60	90	102
	<b>DAYS</b>	NA	NA	NA	NA	NA	NA	5	10	15	17
<b>3/9</b>	<b>PROGRESS</b>	NA	NA	NA	NA	NA	NA	NA	NA	3%	3%
	<b>HOURS</b>	NA	NA	NA	NA	NA	NA	NA	30	60	72
	<b>DAYS</b>	NA	NA	NA	NA	NA	NA	NA	5	10	12
<b>3/23</b>	<b>PROGRESS</b>	NA	NA	NA	NA	NA	NA	NA	NA	NA	NA
	<b>HOURS</b>	NA	NA	NA	NA	NA	NA	NA	NA	30	42
	<b>DAYS</b>	NA	NA	NA	NA	NA	NA	NA	NA	5	7
<b>3/30</b>	<b>PROGRESS</b>	NA	NA	NA	NA	NA	NA	NA	NA	NA	NA
	<b>HOURS</b>	NA	NA	NA	NA	NA	NA	NA	NA	NA	12
	<b>DAYS</b>	NA	NA	NA	NA	NA	NA	NA	NA	NA	2

## Progress and Attendance Guidelines-Quarter 4

STUDENT START DATES DOWN	SCHOOL DAYS ACROSS	4/3	4/10	4/17	4/24	5/1	5/8	5/15	5/22	5/29	End of QTR 4 6/3
8/25	PROGRESS	76%	79%	82%	84%	87%	90%	93%	96%	98%	100%
	HOURS	828	858	888	918	948	978	1008	1038	1062	1080
	DAYS	138	143	148	153	158	163	168	173	177	180
9/2	PROGRESS	73%	76%	79%	81%	84%	87%	90%	93%	95%	97%
	HOURS	798	828	858	888	918	948	978	1008	1032	1050
	DAYS	133	138	143	148	153	158	163	168	172	175
9/8	PROGRESS	71%	74%	77%	78%	81%	84%	87%	90%	93%	95%
	HOURS	774	804	834	864	894	924	954	984	1008	1026
	DAYS	129	134	139	144	149	154	159	164	168	171
9/15	PROGRESS	68%	71%	74%	75%	78%	81%	84%	87%	90%	92%
	HOURS	744	774	804	834	864	894	924	954	978	996
	DAYS	124	129	134	139	144	149	154	159	163	166
9/22	PROGRESS	65%	68%	71%	72%	75%	78%	81%	84%	87%	89%
	HOURS	714	744	774	804	834	864	894	924	948	966
	DAYS	119	124	129	134	139	144	149	154	158	161
9/29	PROGRESS	62%	65%	68%	69%	72%	75%	78%	81%	84%	86%
	HOURS	684	714	744	774	804	834	864	894	918	936
	DAYS	114	119	124	129	134	139	144	149	153	156
10/6	PROGRESS	59%	62%	65%	66%	69%	72%	75%	78%	81%	83%
	HOURS	654	684	714	744	774	804	834	864	888	906
	DAYS	109	114	119	124	129	134	139	144	148	151
10/13	PROGRESS	57%	60%	63%	65%	68%	71%	74%	77%	79%	81%
	HOURS	624	654	684	714	744	774	804	834	858	876
	DAYS	104	109	114	119	124	129	134	139	143	146
10/20	PROGRESS	54%	57%	60%	62%	65%	68%	71%	74%	76%	78%
	HOURS	594	624	654	684	714	744	774	804	828	846
	DAYS	99	104	109	114	119	124	129	134	138	141
10/27	PROGRESS	51%	54%	57%	59%	62%	65%	68%	71%	73%	75%
	HOURS	564	594	624	654	684	714	744	774	798	816
	DAYS	94	99	104	109	114	119	124	129	133	136
11/3	PROGRESS	48%	51%	54%	56%	59%	62%	65%	68%	70%	72%
	HOURS	534	564	594	624	654	684	714	744	768	786
	DAYS	89	94	99	104	109	114	119	124	128	131
11/10	PROGRESS	45%	48%	51%	53%	56%	59%	62%	65%	67%	69%
	HOURS	504	534	564	594	624	654	684	714	738	756
	DAYS	84	89	94	99	104	109	114	119	123	126
11/17	PROGRESS	42%	45%	48%	50%	53%	56%	59%	62%	64%	66%
	HOURS	474	504	534	564	594	624	654	684	708	726
	DAYS	79	84	89	94	99	104	109	114	118	121
11/24	PROGRESS	39%	42%	45%	47%	50%	53%	56%	59%	61%	63%
	HOURS	444	474	504	534	564	594	624	654	678	696
	DAYS	74	79	84	89	94	99	104	109	113	116

<b>STUDENT START DATES DOWN</b>	<b>SCHOOL DAYS ACROSS</b>	4/3	4/10	4/17	4/24	5/1	5/8	5/15	5/22	5/29	End of QTR 4 6/3
<b>12/1</b>	<b>PROGRESS</b>	38%	41%	44%	46%	49%	51%	54%	57%	60%	62%
	<b>HOURS</b>	432	462	492	522	552	582	612	642	666	684
	<b>DAYS</b>	72	77	82	87	92	97	102	107	111	114
<b>12/8</b>	<b>PROGRESS</b>	35%	38%	41%	43%	46%	49%	51%	54%	57%	59%
	<b>HOURS</b>	402	432	462	492	522	552	582	612	636	654
	<b>DAYS</b>	67	72	77	82	87	92	97	102	106	109
<b>12/15</b>	<b>PROGRESS</b>	32%	35%	38%	40%	43%	46%	49%	51%	54%	56%
	<b>HOURS</b>	372	402	432	462	492	522	552	582	606	624
	<b>DAYS</b>	62	67	72	77	82	87	92	97	101	104
<b>1/5</b>	<b>PROGRESS</b>	29%	32%	35%	37%	40%	43%	46%	49%	51%	53%
	<b>HOURS</b>	342	372	402	432	462	492	522	552	576	594
	<b>DAYS</b>	57	62	67	72	77	82	87	92	96	99
<b>1/12</b>	<b>PROGRESS</b>	26%	29%	32%	34%	37%	40%	43%	46%	48%	50%
	<b>HOURS</b>	312	342	372	402	432	462	492	522	546	564
	<b>DAYS</b>	52	57	62	67	72	77	82	87	91	94
<b>1/20</b>	<b>PROGRESS</b>	23%	26%	29%	31%	34%	37%	40%	43%	46%	47%
	<b>HOURS</b>	288	318	348	378	408	438	468	498	522	540
	<b>DAYS</b>	48	53	58	63	68	73	78	83	87	90
<b>1/26</b>	<b>PROGRESS</b>	21%	24%	27%	29%	32%	35%	38%	41%	43%	45%
	<b>HOURS</b>	264	294	324	354	384	414	444	474	498	516
	<b>DAYS</b>	44	49	54	59	64	69	74	79	83	86
<b>2/2</b>	<b>PROGRESS</b>	18%	21%	24%	26%	29%	32%	35%	38%	40%	42%
	<b>HOURS</b>	234	264	294	324	354	384	414	444	468	486
	<b>DAYS</b>	39	44	49	54	59	64	69	74	78	81
<b>2/9</b>	<b>PROGRESS</b>	15%	18%	21%	23%	26%	29%	32%	35%	37%	39%
	<b>HOURS</b>	204	234	264	294	324	354	384	414	438	456
	<b>DAYS</b>	34	39	44	49	54	59	64	69	73	76
<b>2/17</b>	<b>PROGRESS</b>	13%	16%	19%	21%	24%	27%	30%	33%	35%	37%
	<b>HOURS</b>	174	204	234	264	294	324	354	384	408	426
	<b>DAYS</b>	29	34	39	44	49	54	59	64	68	71
<b>2/23</b>	<b>PROGRESS</b>	11%	14%	17%	19%	22%	25%	28%	31%	33%	35%
	<b>HOURS</b>	150	180	210	240	270	300	330	360	384	402
	<b>DAYS</b>	25	30	35	40	45	50	55	60	64	67
<b>3/2</b>	<b>PROGRESS</b>	8%	11%	14%	16%	19%	22%	25%	28%	30%	32%
	<b>HOURS</b>	120	150	180	210	240	270	300	330	354	372
	<b>DAYS</b>	20	25	30	35	40	45	50	55	59	62
<b>3/9</b>	<b>PROGRESS</b>	5%	8%	11%	13%	16%	19%	22%	25%	27%	29%
	<b>HOURS</b>	90	120	150	180	210	240	270	300	324	342
	<b>DAYS</b>	15	20	25	30	35	40	45	50	54	57
<b>3/23</b>	<b>PROGRESS</b>	2%	5%	8%	10%	13%	16%	19%	22%	24%	26%
	<b>HOURS</b>	60	90	120	150	180	210	240	270	294	312
	<b>DAYS</b>	10	15	20	25	30	35	40	45	49	52

